

Electric Vehicle AC Charger

AX Series - User Manual

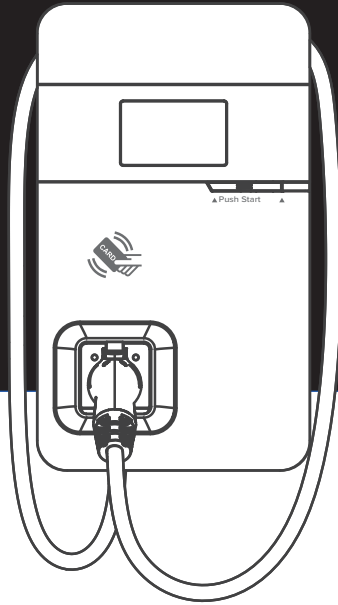

High-End Edition

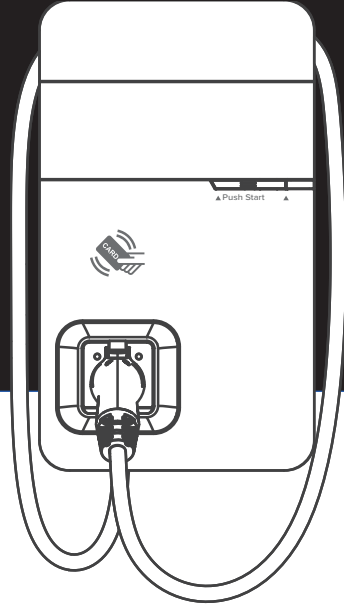

Classic Edition



NEMA 4R



Authorization



Management



Repairable



Outdoors

version. W84A99900147-HB3

CONTENT

1. Important Safety Instructions	1
2. Federal Communication Commission Interference Statement	3
3. Industry Canada statement	5
4. Interface	7
4.1 High-End Edition.....	7
4.2 Classic Edition	8
4.3 Bottom Case and Wire box.....	9
5. Dimensions (unit:mm)	10
6. Specification	11
7. Status Description of the Charger Indication Lights	12
8. Screen Instructions	13
9. Installation Instructions	15
9.1 Safety Requirements	15
9.2 Power Grid Connection and Grounding Type	16
9.3 Packing List	18
9.4 Tools and Materials Required	19
9.5 Wall-Mount Bracket Installation Requirements	19
9.6 AX Installation Requirements.....	20
9.7 Installation Steps	20
10. Charger Standard Setting	30
10.1 Time setting	30
10.2 Wi-Fi Setup	32
10.3 4G Setup (for the optional 4G Edition).....	33
10.4 Re-checking the Wi-Fi and 4G Signal Strength on Power-Up	34
11. Local Load Balance Mode (OFFLINE only)	36
11.1 Operating procedure	38
12. Operating Instructions	48
12.1 Error and Warning Message	50
13. Maintenance and Repair	52
13.1 Daily Maintenance	52
13.2 Maintenance Spares	52
13.3 Warranty and Maintenance	53
13.4 Maintenance History	54



1. Important Safety Instructions

Please read all Important Safety Instructions as well as charging instructions in your vehicle owner's manual before attempting to charge your electric vehicle. Failure to do so can result in death or severe injury. Save this user manual for future reference. There are many safety features built into the charger. Read all the safety information and warnings in this manual to avoid any risks or hazards and risks associated with using this charger.



Warning

When using electric products, basic precautions should always be followed. This manual contains important instructions, including the following, which must be followed during installation, operation and maintenance.

- Do not install or use the charger near flammable, explosive, corrosive, or combustible materials, chemicals, or vapors.
- Turn off the input power of the charger before performing any maintenance on the charger.
- The device is designed only for vehicles that are compatible with the SAE J1772 Level 2 charging standard.
- Do not use the charger if it is defective, or if it appears cracked, frayed, broken, or damaged.
- Do not attempt to open, disassemble, repair, tamper with, or modify the charger. Contact our Customer Service department if you have any questions or require the replacement or repair of any parts.
- Do not use the charger when either you, the vehicle or charger is exposed to severe rain, snow, or other severe weather.
- When transporting the charger, handle it with care and do not drag or step on the device.
- Do not touch the charging connector terminal with any sharp metallic objects, in order to prevent damage.
- Do not forcefully pull the charging cable, damage it with sharp objects, or place fingers or insert foreign objects into any part of the charging connector.



- Risk of explosion. This device has arcing or sparking parts that should not be exposed to flammable vapors.
- Risk of electric shock. Do not remove the cover or attempt to open the enclosure of this device. There are no user-serviceable parts inside. Contact a qualified service company if you require any service repairs.
- To reduce the risk of fire, connect only to a circuit provided with 60 amperes maximum branch circuit overcurrent protection in accordance with the national Electrical Code, ANSI/NFPA 70, and the Canadian Electrical Code, Part I, C22.1
- This charger should be installed, adjusted, and serviced by a qualified electrician or a person familiar with the construction and operation of this type of charger and the dangers involved. Failure to observe this precaution could result in damage to the charger, or even severe injury or death.
- Incorrect installation and testing of the charger could potentially damage either the vehicle's battery and the charger. This type of damage is not covered by our warranty policy.
- Ensure that the charging cable is well-positioned during the charging process, to avoid the cable getting stepped on, tripped over, or subjected to damage or stress.
- Do not use this charger with a frayed charging cable having damaged insulation or any other sign of damage.
- Ensure that the wire type, diameter, current rating, and temperature rating comply with the local electrical standards and requirements in your local area.
- Before starting the installation, turn off all power.
- For permanently connected equipment, protective grounding and bonding terminals-field wiring terminals for connection of equipment-grounding conductors are identified by: "G," "GR," "GND," "Ground," "Grounding" or the ground symbol, either on a wiring diagram provided on the unit, or a marking on the wiring diagram attached to the unit.
- This device should be supervised when used around children.
- Do not put fingers into the electric vehicle connector
- The device is not to be lifted or carried by either the flexible cord or the EV cable

2. Federal Communication Commission Interference Statement

This device complies with Part 15 of the FCC Rules. Operation is subject to the following two conditions: (1) This device may not cause harmful interference, and (2) this device must accept any interference received, including interference that may cause undesired operation.

This equipment has been tested and found to comply with the limits for a Class B digital device, pursuant to Part 15 of the FCC Rules. These limits are designed to provide reasonable protection against harmful interference in a residential installation. This equipment generates, uses and can radiate radio frequency energy and, if not installed and used in accordance with the instructions, may cause harmful interference to radio communications. However, there is no guarantee that interference will not occur in a particular installation. If this equipment does cause harmful interference to radio or television reception, which can be determined by turning the equipment off and on, the user is encouraged to try to correct the interference by one of the following measures:

- Reorient or relocate the receiving antenna.
- Increase the separation between the equipment and receiver.
- Connect the equipment into an outlet on a circuit different from that to which the receiver is connected.
- Consult the dealer or an experienced radio/TV technician for help.

FCC Caution: Any changes or modifications not expressly approved by the party responsible for compliance could void the user's authority to operate this equipment

This transmitter must not be co-located or operating in conjunction with any other antenna or transmitter.

Radiation Exposure Statement:

This equipment complies with FCC radiation exposure limits set forth for an uncontrolled environment. This equipment should be installed and operated with minimum distance 20cm between the radiator & your body.

3. Industry Canada statement:

This device complies with ISED's licence-exempt RSSs. Operation is subject to the following two conditions: (1) This device may not cause harmful interference, and (2) this device must accept any interference received, including interference that may cause undesired operation.

Le présent appareil est conforme aux CNR d'ISED applicables aux appareils radio exempts de licence. L'exploitation est autorisée aux deux conditions suivantes : (1) le dispositif ne doit pas produire de brouillage préjudiciable, et (2) ce dispositif doit accepter tout brouillage reçu, y compris un brouillage susceptible de provoquer un fonctionnement indésirable.

Radiation Exposure Statement:

This equipment complies with ISED radiation exposure limits set forth for an uncontrolled environment. This equipment should be installed and operated with greater than 20cm between the radiator & your body.

Déclaration d'exposition aux radiations:

Cet équipement est conforme aux limites d'exposition aux rayonnements ISED établies pour un environnement non contrôlé. Cet équipement doit être installé et utilisé à plus de 20 cm entre le radiateur et votre corps.

This device is intended only for OEM integrators under the following conditions: (For module device use)

The antenna must be installed and operated with greater than 20cm between the antenna and users, and

The transmitter module may not be co-located with any other transmitter or antenna.

As long as the 2 conditions above are met, further transmitter test will not be required. However, the OEM integrator is still responsible for testing their end-product for any additional compliance requirements required with this module installed.

Cet appareil est conçu uniquement pour les intégrateurs OEM dans les conditions suivantes: (Pour utilisation de dispositif module)

L'antenne doit être installé et exploité avec plus de 20 cm entre

l'antenne et les utilisateurs, et

2) Le module émetteur peut ne pas être coimplanté avec un autre émetteur ou antenne.

Tant que les 2 conditions ci-dessus sont remplies, des essais supplémentaires sur l'émetteur ne seront pas nécessaires. Toutefois, l'intégrateur OEM est toujours responsable des essais sur son produit final pour toutes exigences de conformité supplémentaires requis pour ce module installé.

IMPORTANT NOTE:

In the event that these conditions cannot be met (for example certain laptop configurations or co-location with another transmitter), then the Canada authorization is no longer considered valid and the IC ID can not be used on the final product. In these circumstances, the OEM integrator will be responsible for re-evaluating the end product (including the transmitter) and obtaining a separate Canada authorization.

NOTE IMPORTANTE:

Dans le cas où ces conditions ne peuvent être satisfaites (par exemple pour certaines configurations d'ordinateur portable ou de certaines co-localisation avec un autre émetteur), l'autorisation du Canada n'est plus considéré comme valide et l'ID IC ne peut pas être utilisé sur le produit final. Dans ces circonstances, l'intégrateur OEM sera chargé de réévaluer le produit final (y compris l'émetteur) et l'obtention d'une autorisation distincte au Canada.

4. Interface

4.1 High-End Edition

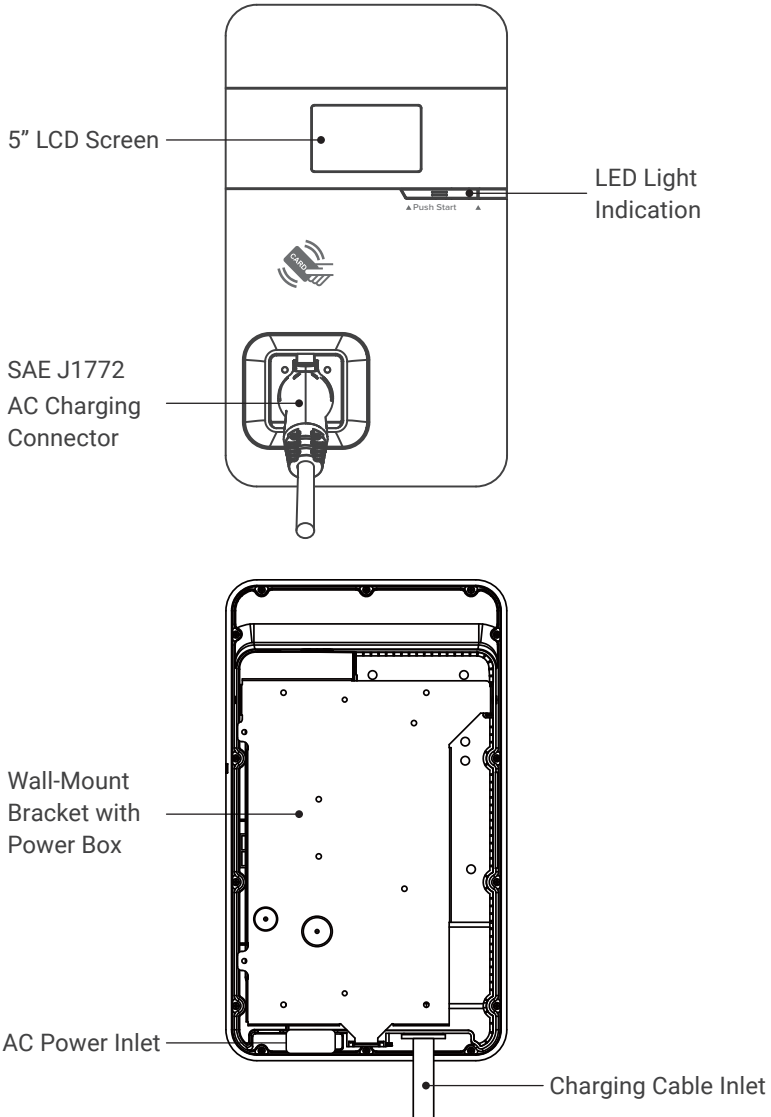

4.2 Classic Edition

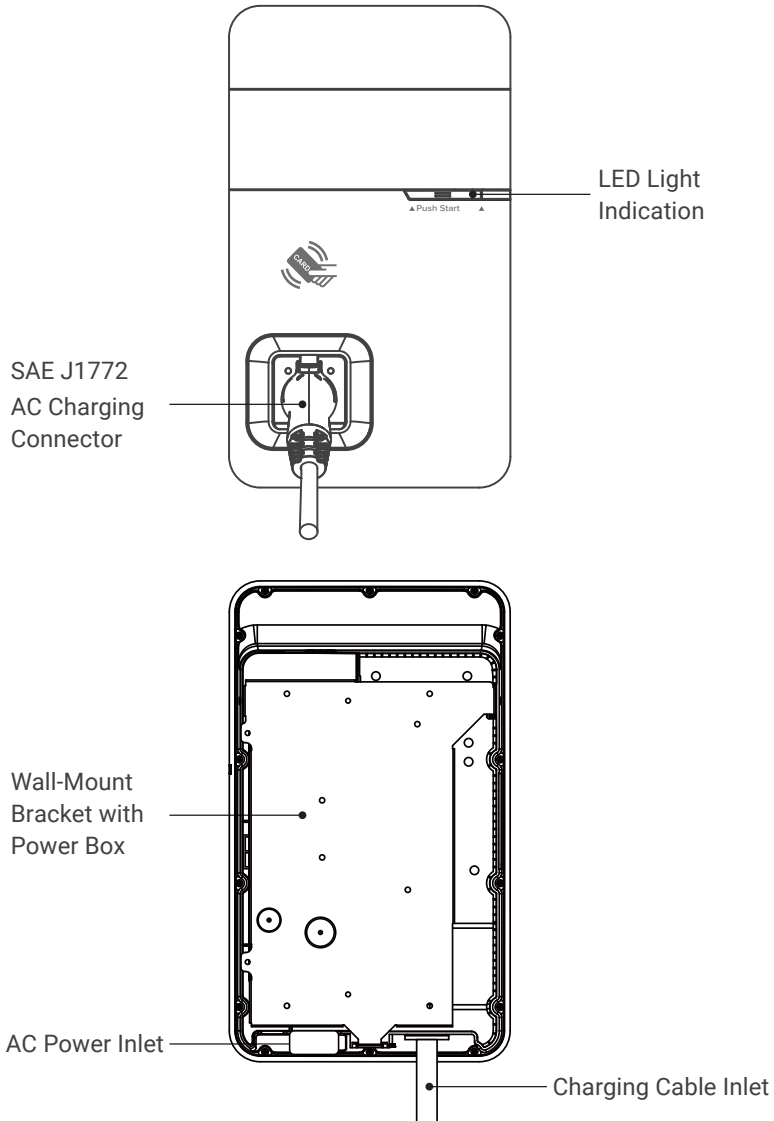

4.3 Bottom Case and Wire box

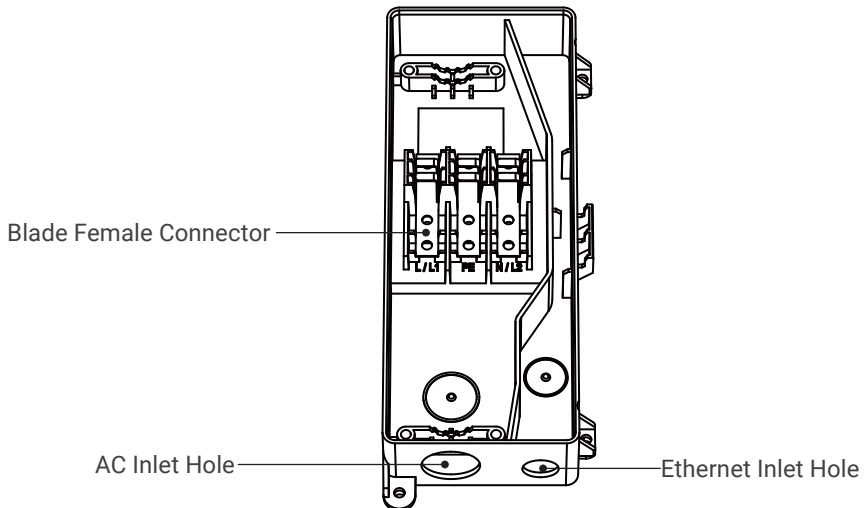
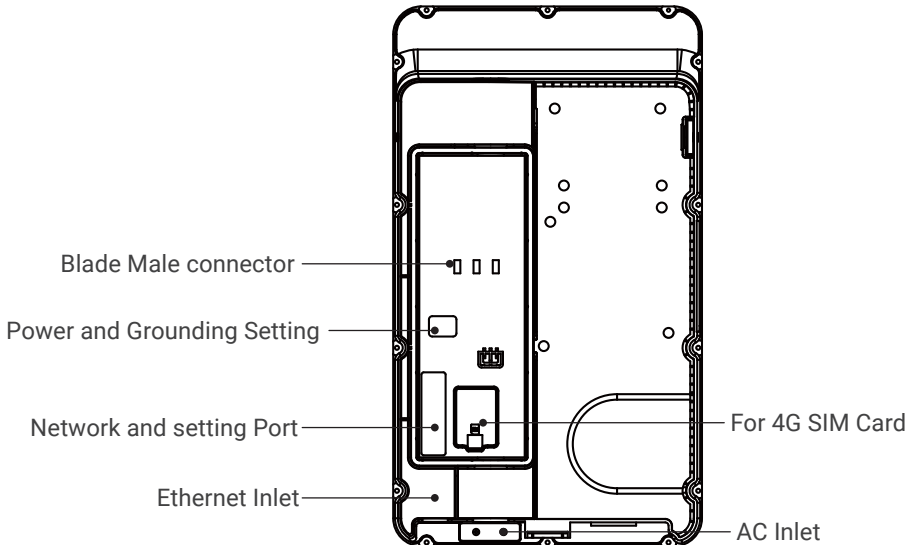

5. Dimensions (unit:mm)

5.1 Main Size of Charger

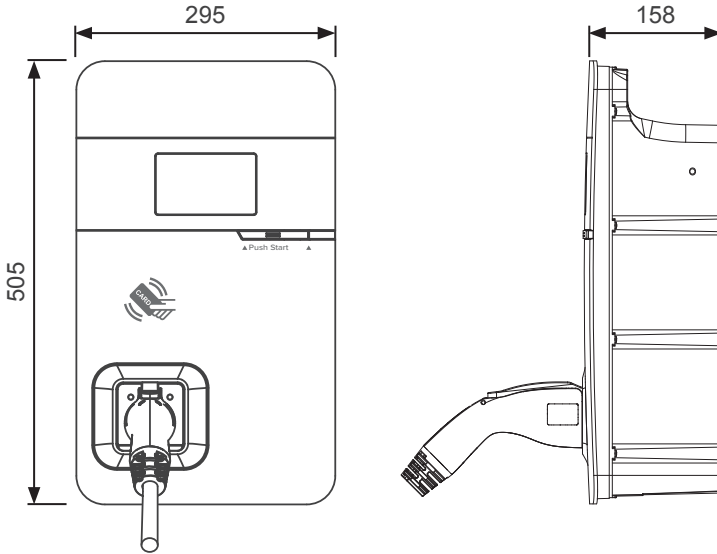

5.2 Wall-Mount Bracket

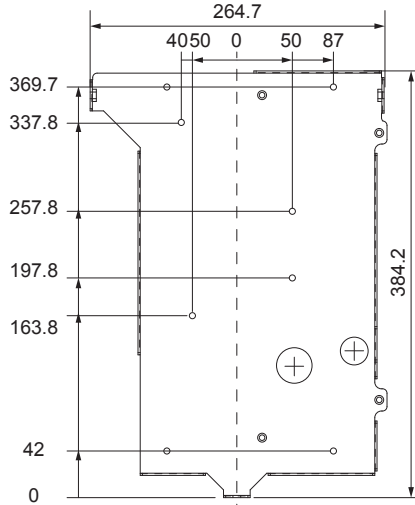

6. Specification

Rated Input Voltage	200-240 VAC / Single Phase
Rated Output Current	48A
AC Power Frequency	50/60 Hz
Input Protection	UVP, OVP, Surge protection, Ground fault
Output Protection	OCP, Control pilot fault, Residual current protection
Output Interface	SAE J1772 AC Charging Connector
Storage Temperature	-40°C to + 70°C
Operation Temperature	-30°C to +50°C
Relative Operation Humidity	Up to 85% at 50°C non-condensing
Relative Storage Humidity	Up to 95% at 50°C non-condensing
Display	LED pilot lamp (standard), 5-inch LCD (High-end)
User Authorization	RFID (ISO/IEC 14443A/B, ISO/IEC 15693, FeliCa™, Mifare), ISO15118
RJ45 Cable Inlet ^{*1}	10M/100M Base-T
Wi-Fi Function ^{*1}	802.11 b/g/n
2G/3G/4G Finction ^{*1}	LTE, UMTS/HSPA(+), GSM/GPRS/EDGE
Cable Length	5M (From charger's body to lower edge of charging connector)
Protection Level	NEMA TYPE 4
Installation Type	Wall-Mount
Altitude	≤ 2000 m
Weight	9±0.5kg
Dimensions	295 (W) x 158 (D) x 505 (H) mm

*1 4G Version

7. Status Description of the Charger Indication Lights







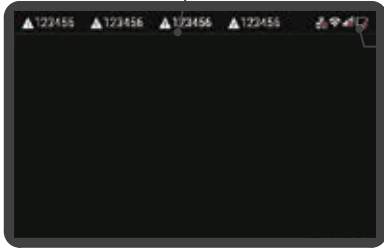



Work status	Blue	Green	Red
Initial	Constantly Bright (White)		
Idle Backend connected Sleep	-	Breath	-
Idle Backend connected	-	Constantly Bright	-
Idle Backend disconnected Sleep	-	Breathing (Yellow)	
Idle Backend disconnected	-	Constantly Bright (Yellow)	
Authorize RFID authorization Pass		Flicker 3 sec	
Authorize RFID authorization Fail			Flicker 3 sec
Handshaking	Constantly Bright	-	-
Charging	Flicker	-	-
Terminate	Constantly Bright	-	-
Complete	Constantly Bright	-	-
Maintenance Upgrade	-	Flicker (Yellow)	
Reservation	-	Flicker	

8. Screen Instructions

8.1 Status bar



Status Code

-  Ethernet connected with internet
-  Ethernet Not Connected
-  Ethernet connected without internet
-  WiFi connected with internet
-  WiFi Not Connected
-  WiFi connected without internet
-  4G connected with internet
-  4G Not Connected
-  4G connected without internet
-  Backend Online
-  Backend Offline

8.2 Status Code Table

*For latest status code, please visit our website.

Status Code	Description
011004	RCD/CCID self-test fail
011009	output relay welding
011010	output relay driving fault
011021	WiFi module broken
011036	Rotary switch fault
012200	System input OVP
012203	System input UVP
012212	System input drop
012216	System output OCP
012223	System ambient/inlet OTP
012233	RCD/CCID trip

012241	WiFi module communication fail
012242	3G/4G module communication fail
012243	RFID module communication fail
012254	Fail to create share memory
012255	CSU initialization failed
012256	Ground Fault
012257	MCU self-test Fault
012262	Syetem output Circuit Short
012344	Meter IC communication timeout
012345	Pilot negative error
013607	CSU fimrware update fail
013622	Disconnected from Internet through Ethernet
013623	Disconnected from Internet through WiFi
013625	Disconnected from AP through WiFi
023703	Pilot fault

9. Installation Instructions

9.1 Safety Requirements

- Read this user manual thoroughly and make sure to review all local building and electrical codes before installing the AC charger. A qualified technician should install the AC charger according to the user manual and local safety regulations.
- Use appropriate protection when connecting to the main power distribution cable.
- Type B, C or D breaker with a rating current of 60Amp should be installed in the upstream AC distribution box.
- Disconnect switch for each ungrounded conductor of AC input shall be provided by others in accordance with the National Electric Code, ANSI/ NFPA 70.
- Verify that the Wall Connector is properly grounded. The ground connection must be bonded in the upstream power supply for proper operation. Check all physical connections, including the wire box terminals, electrical panel(s), and wire box. In residential power supplies, check the bond between ground and neutral at the main panel. If connected to a step- down transformer, contact the transformer's manufacturer for direction on how to bond the ground connection.

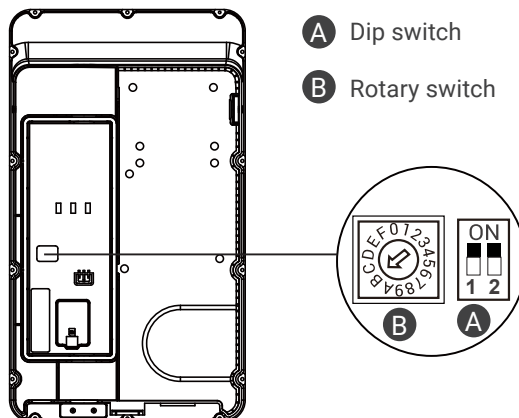

9.2 Power Grid Connection and Grounding Type

- This AC charger supports different power grid connections and grounding types. You can configure through the setting dip switch. Setting methods are shown below.
- Before setting the dip switch, make sure the input power is turned OFF.
- Use a non-conductive object to set the dip switch.

	Switch 1 (Power Grid Type)	Switch 2 (Grounding System)
ON	LN	IT
OFF	LL	TT-TN

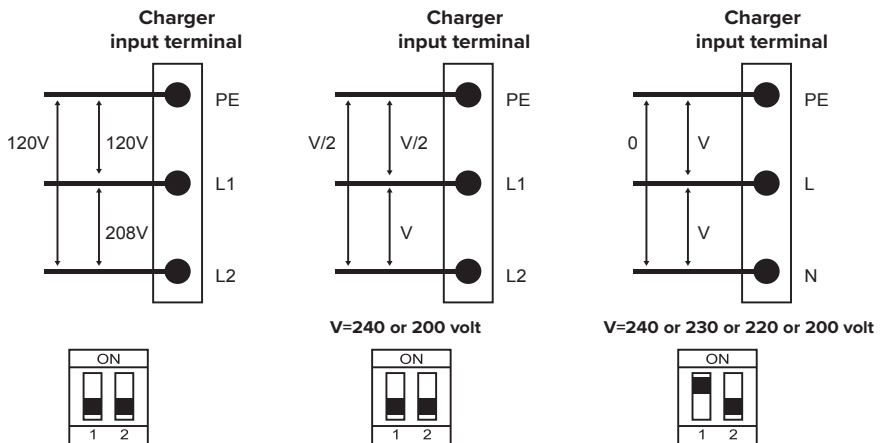

*Note 1: The default value in North America and Japan is (LL / TT-TN).

*Note 2: The default value for other regions is (LN / TT-TN).

*Note 3: If it is not the above standard grid type, please contact our technical staff for assistance and confirmation.

Maximum Output Current

This AC charger can support different maximum output current through the setting rotary switch. Setting methods are shown below

- Before setting the rotary switch, make sure the input power is turned OFF.
- Use a non-conductive object to set the rotary switch.

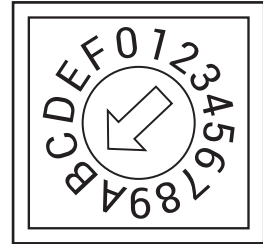

Switch Setting Number	0	1	2	3	4	5	6	7
Maximum Output Current	Test Mode	6A	8A	10A	13A	16A	20A	25A

Switch Setting Number	8	9	A	B ^{*1}	C	D	E	F
Maximum Output Current	30A	32A	40A	48A	Invalid Setting	Invalid Setting	Invalid Setting	Slave Mode

* Note 1: The default is 48A.

9.3 Packing List

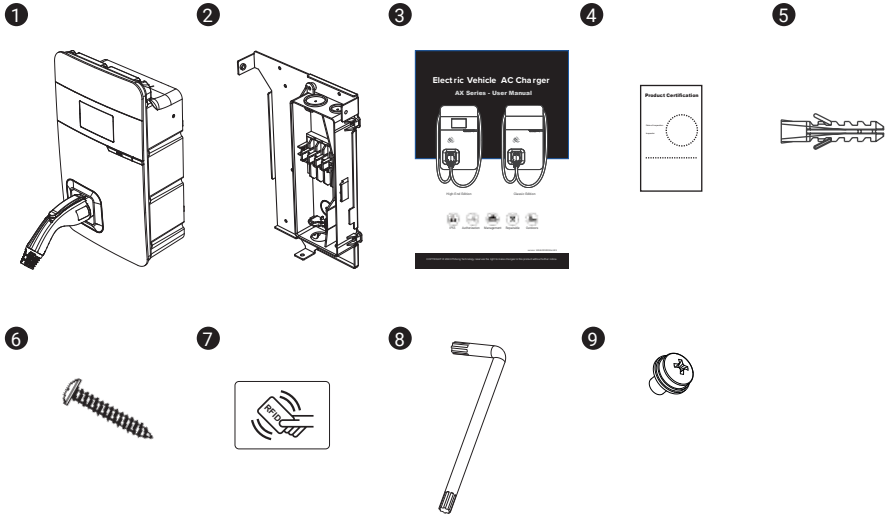

No.	Product Name	Quantity	Note
1	AC Charger (With Charging Cable)	1	
2	Wall-Mount Bracket & Inlet Box	1	
3	User Manual	1	
4	Product Certification	1	
5	Expansion Screw	4	
6	M5 Self-Tapping Screws	4	
7	RFID Card	2	
8	Torx/T30 L-Wrench	1	
9	M5 Screw	5	

9.4 Tools and Materials Required

Tools required before installing the charger onto the Wall-Mount Bracket are:

- Wire stripper
- Crimpers for ring terminals
- Phillips screwdriver for M4 – M6 1-3/8 inch or 34 mm drill bit
- Voltmeter or digital multimeter (for measuring AC voltage at the installation site)
- The inserting cable should meet the best waterproof performance requirements. It is recommended to use a 3 core / 6AWG or 14mm² cable (XLPE-90°C, THHN-90°C, or equivalent) to pull the cable from the distribution box. The maximum outer diameter of the cable should be 16mm–23mm.
- Level ruler
- Pencil or marker
- Machine drill
- Ring terminal (recommend type 14-5) for 6 AWG wire, and fixed by M5 slotted head screw.
- It is recommended to use 1-inch liquidtight flexible metal conduit compliant with NEMA 4 class
- Slotted head screwdriver for M5

9.5 Wall-Mount Bracket Installation Requirements

Before installing the wall-mount bracket, you should confirm that the loading capacity of the wall can reach a weight of 40 kg. When installing on a cement wall, you can use the included expansion screw to install the bracket and use a cement drill to drill holes on the cement wall (Ø8mm) following the hole spacing in accordance with 3.2.

When installing on a wooden wall, you can directly use the included M5 self-tapping screws to install the wall-mount bracket and use the wall-mount backplane to lock and install on the wall directly.

9.6 AX Installation Requirements

- To select the best location and position to install the wall-mount unit, you should first determine the parking position of the vehicle to ensure the charging connector can be easily inserted into the vehicle charging inlet.
- The wall-mount unit should be located:
- In a well-ventilated area. Avoid installing in closed boxes or near to exothermic chargers.
- 1.2 meters or 4 feet above the floor.
- 250mm (10inches) from any obstacles to allow cables to loop around the wires and to allow related maintenance.
- If in an enclosed garage, on the side of vehicle charging inlet.

9.7 Installation Steps

Warning for Wi-Fi and 4G versions:

Due to different congenital environments, it is recommended to first conduct Wi-Fi and 4G module network signal tests before finalizing your settings. It is recommended that the RSSI (Received Signal Strength Indication) value should be higher than -65dBm. If it is lower than this value, it may result in a weak Wi-Fi or 4G connection or disconnection due to external interference in the area.

STEP 1

Installation of the wall-mounted metal plate

Take out the wall-mounted metal plate and locate all the installation holes. Use as a template to mark on the wall with a pencil or any tool, and insert 4 sets of expansion bolts (M5X40mm) into the wall, as shown in the figure. Install the wall-mounted metal plate on the cement wall.

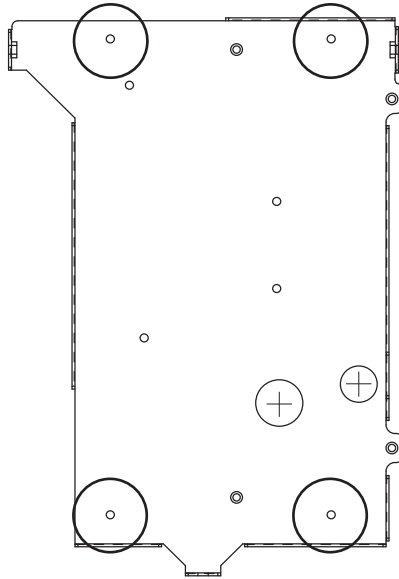

STEP 2

Installation of the wire box

First, remove the waterproof cover at the inlet end marked as "AC In". Then, install the accessory "1-inch liquidtight flexible metal conduit" at the inlet of the power cord, and attach the wire box to the wall-mounted metal plate with screws.

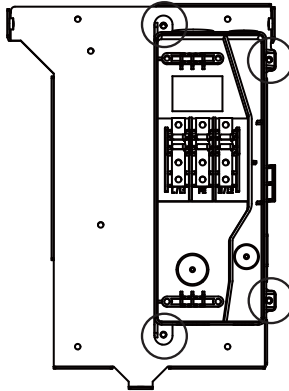

STEP 3

Installation of the AC power cord

The cross-sectional area of the three power cords should be AWG 6 or 14mm². The power cords should be fully crimped and connected with ring terminals. The ring terminals should be attached to the wire box with M5 screws, with a tightening torque of 40kg-cm. Please refer to label on the wire box for the correct positions, where the positions are L1/L, GND/PE, and L2/N, respectively, from the left to the right.

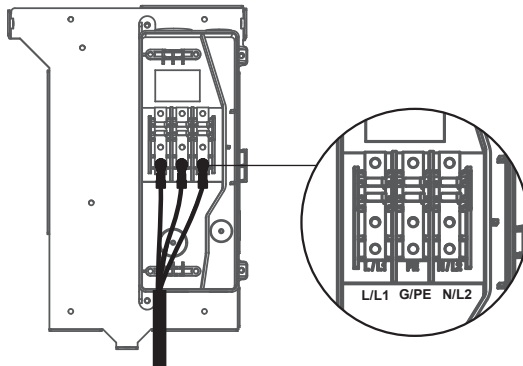

STEP 4

Installation and setting of the network cable

Remove the waterproof plug from the Internet interface at the bottom left of the wire box. Feed the network cable into the wire box through the network cable entrance. Once the network cable is in, insert the RJ45 connector into the connection port on the back of the charger.

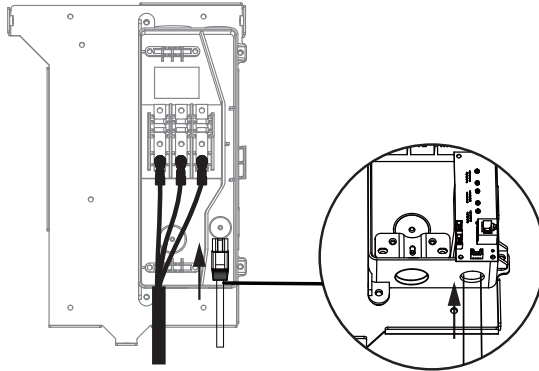

STEP 5

Setting of the power supply type and grounding type

There are different settings depending on the LAN and the country where the machine is installed. Please refer to Section 9.2 "Power Grid Connection and Grounding Type" for details.

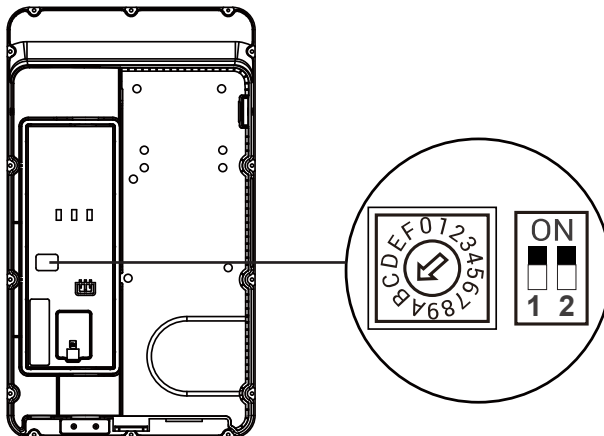

STEP 6

Installation of the SIM card (only available for 4G models)

Attention: Please confirm that the SIM card password has been removed prior to installation, as the charger post does not support SIM cards with passwords.

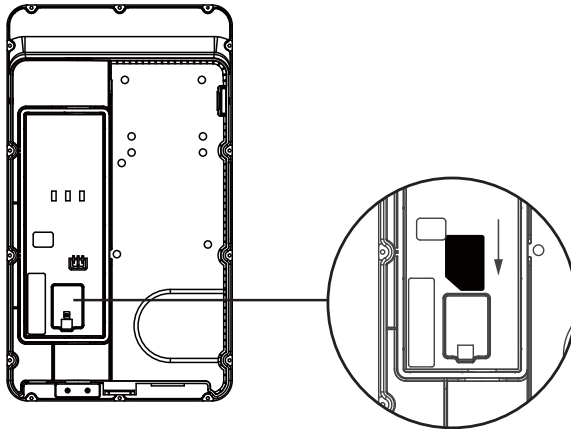

STEP 7

Installation of the charger

First, connect the network cable to the charger.

NOTE! The network cable needs to be connected to the correct socket.

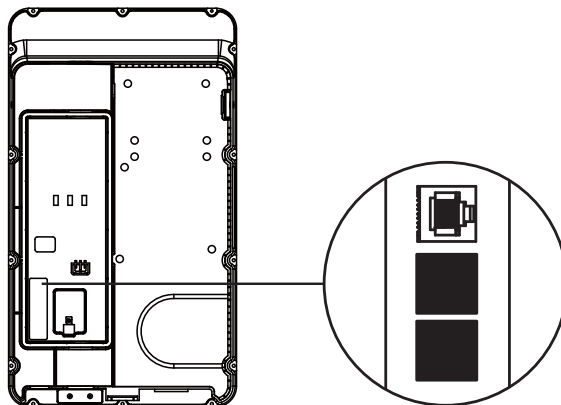

Next, move the charger equipment in a horizontal direction, so that the AC connector of the equipment can be inserted into the conductive spring plate of the wire box. Meanwhile, apply pressure to the equipment, so that the three screw holes of the equipment align with the three holes of the wall-mounted metal plate.

Finally, tighten with the M6 plum screws in the order left - right - bottom, with a tightening torque of 30 kg-cm.

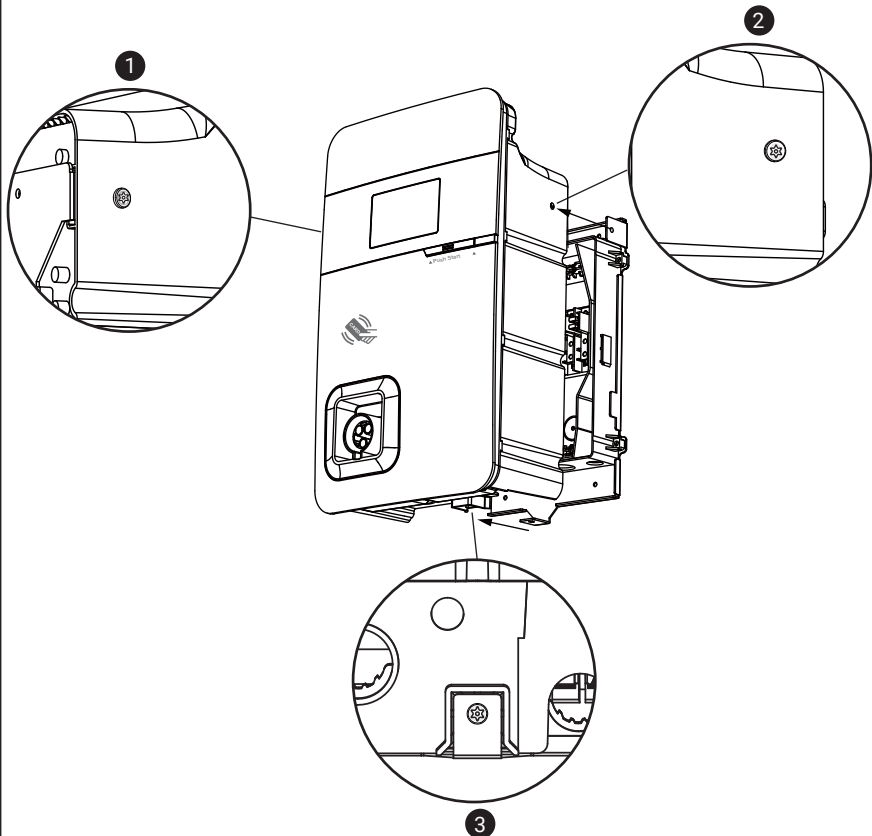

STEP 8

Power on the machine for setting of the charger

For setting instructions, please refer to Section 10.1–10.4 "Charger Standard Setting instructions"

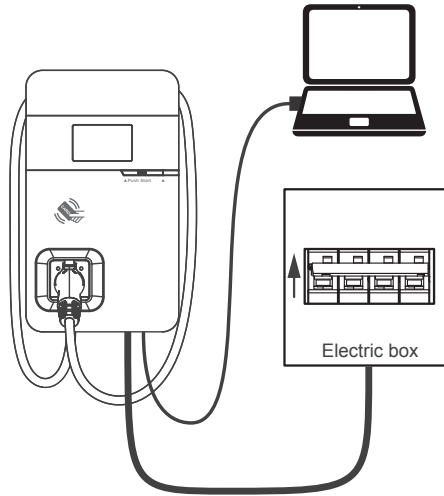

STEP 9

Power off and unplug the connection

Power off the machine and remove the network cable once setting is completed (For those who are in a wired network environment, please go straight to Step 10)

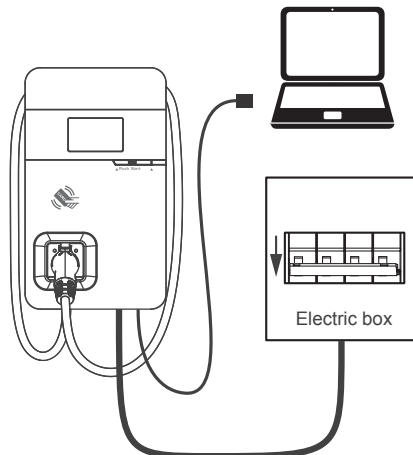

Remove the three screws on the charger in the order bottom - right - left. Pull the network cable out of the wire box, then remove the network cable. Install the waterproof plug, then re-install the charger and wire box.

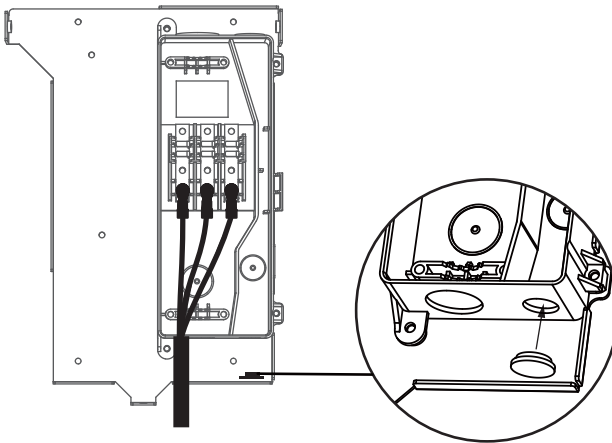
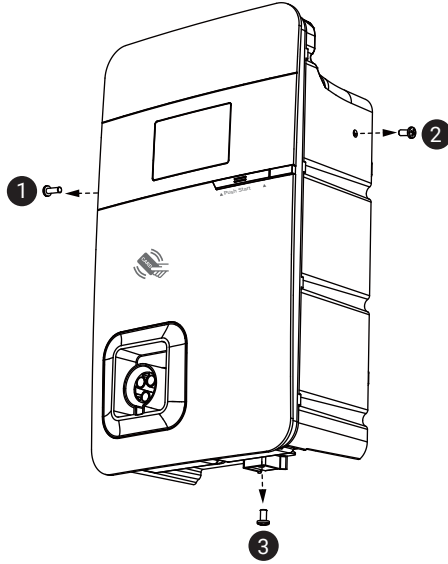

Let the three screw holes of the equipment align with the three holes of the wall-mounted metal plate, then tighten with the M6 plum screws in the order left - right - bottom, with a tightening torque of 30 kg-cm.

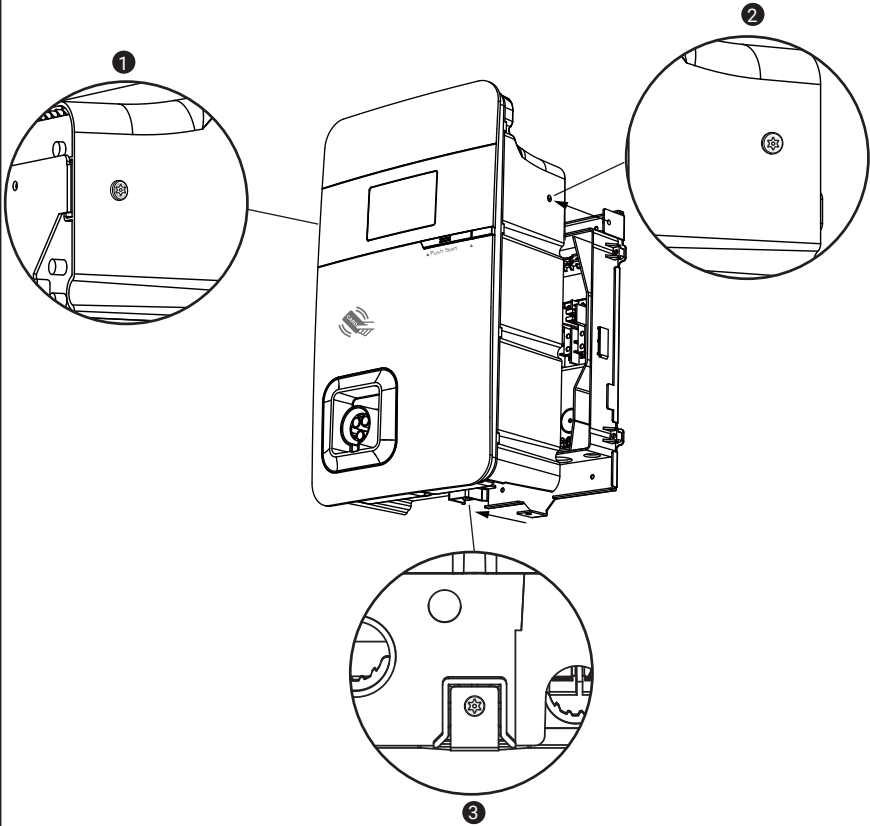

STEP 10

Installation of charging gun wiring

Wrap the charging gun wire around the equipment (about two turns), so that the charging gun wire will not hang down to the ground. Once the wrapping is done, insert the charging gun head into the hole of the charging gun base on the front panel of the machine to complete the installation of the equipment.

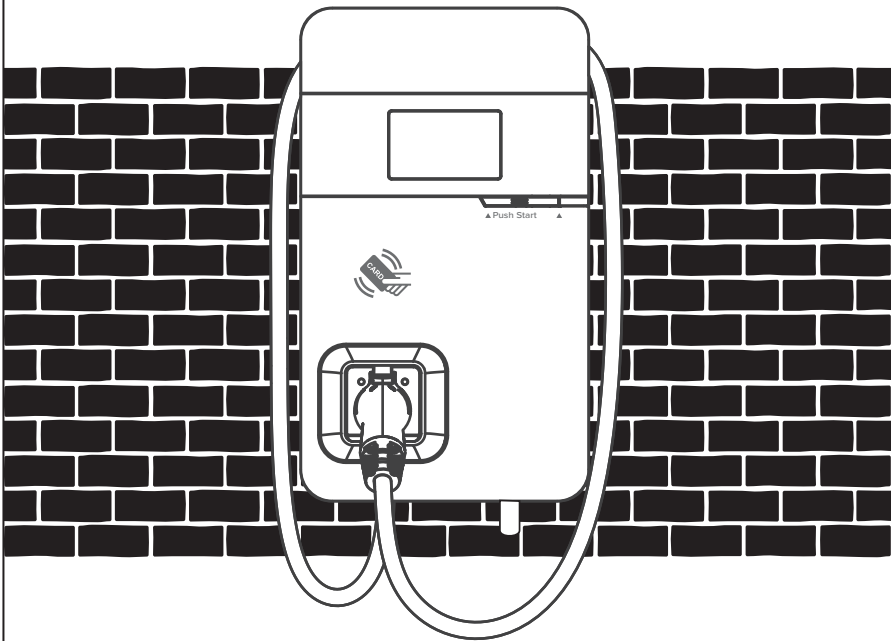

10. Charger Standard Setting

10.1 Time setting

Automatic setting :

The time will be adjusted automatically when the charger connects to the internet.

Time Server :

- time.windows.com
- cn.ntp.org.cn
- tock.stdtime.gov.tw

Note: The firewall and network environment may influence the time server connection.

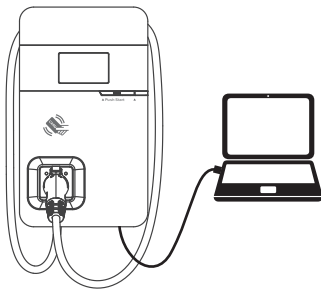

STEP1/ Connect the RJ45 cable to the charger. Connect the RJ45 cable to the notebook.

Use the following IP address:

IP address:

Subnet mask:

Default gateway:

STEP2/ Change the IP address on your laptop computer by accessing the network card settings. Change the TCP / IP automatic IP to fixed IP.

- IP Address:192.168.1.1
- Subnet Mask:255.255.255.0

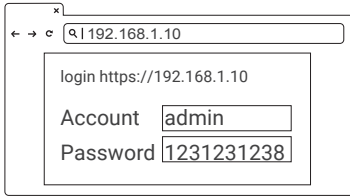

STEP3/ Open a browser and enter IP address 192.168.1.10 to log into the setup page. Use the following credentials to log in.

- Account: admin
- Password: 1231231238

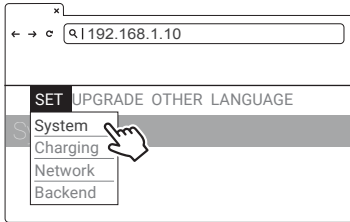

STEP4/ Select "SET" at the top of the webpage to enter the settings page. Select "Network" to enter the network settings page.

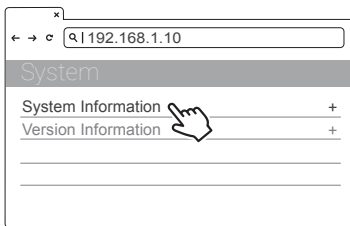

STEP5/

- Click "System information".

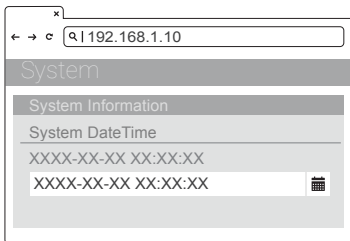

STEP6/

- Click System DateTime.
- Click the calendar graphic on the right to set the current time.

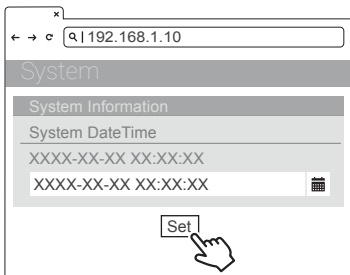

STEP7/

- After you update the settings, click SET and wait until the setting completion window appears.
- For the Networking Edition, restart the charger.
- For Wi-Fi and 4G versions, continue to step 10.2 or 10.3 to complete the settings process.

10.2 Wi-Fi Setup

Tools required before setting

- Notebook with RJ45 interface x 1
- One RJ45 cable connector is male to male x1

Wi-Fi Setting

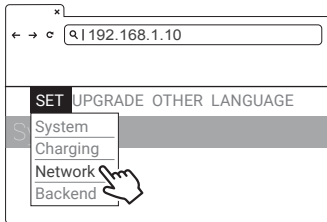

STEP1/ Select "SET" at the top of the webpage to enter the settings page. Select "Network" to enter the network settings page.

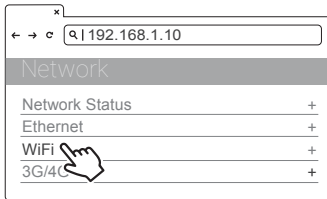

STEP2/ Select Wi-Fi to enter the Wi-Fi Module settings page.

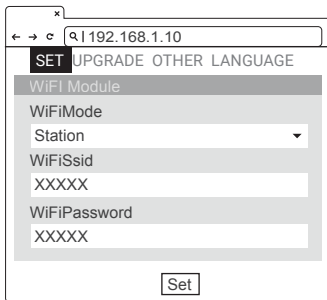

STEP3/ Keep the Wi-Fi Mode set to "Station" and enter the Wi-Fi SSID name and the Wi-Fi password. Save settings by selecting SET.

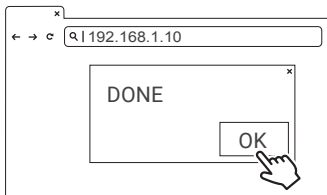

STEP4/ After completion, click SET and wait until the setting completion window appears. Restart the charger.

- For other settings (such as OCPP, etc.), please contact our professional staff.

10.3 4G Setup (for the optional 4G Edition)

Attention: Please confirm that the SIM card password has been removed prior to installation, as the charger post does not support SIM cards with passwords.

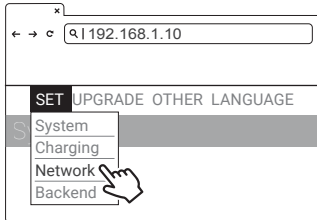

STEP1/ Select "SET" at the top of the webpage to enter the settings page. Select "Network" to enter the network settings page.

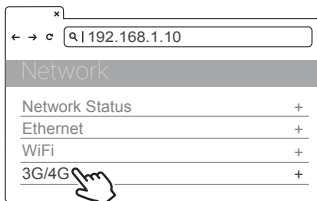

STEP2/ Select 3G/4G module to enter the 4G settings page.

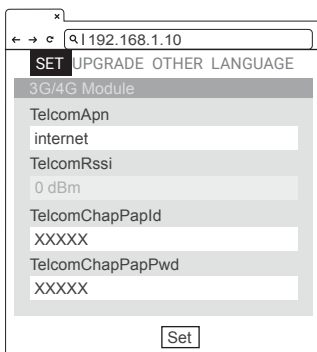

STEP3/ Enter the Carrier APN and then click "OK." Wait for the page to refresh. The page should now show RSSI, and the Network Connection "Status" should show "Connected."

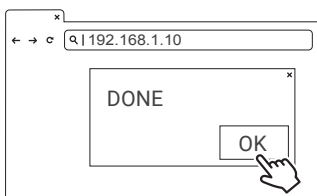

STEP4/ After completion, click SET. Wait for the setting completion window to appear. Click "Confirm" to finish the setting. Restart the charger.

*For other settings (such as OCPP, etc.), please contact our professional staff.

10.4 Re-checking the Wi-Fi and 4G Signal Strength on Power-Up.

After restarting the charger, check the connection signal strength. The RSSI (Received Signal Strength Indication) should be higher than -65dBm. If the value is lower, you may experience a weak Wi-Fi signal connection or even disconnection. The cause could be interference.

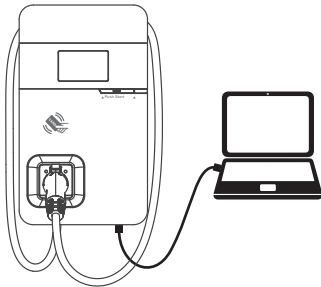

STEP1/ Connect the RJ45 cable to the charger. Connect the RJ45 cable to the notebook.

Use the following IP address :

IP address:

Subnet mask:

Default gateway:

STEP2/ Change the IP address on your laptop computer by accessing the network card settings. Change the TCP / IP automatic IP to fixed IP.

- IP Address:192.168.1.1
- Subnet Mask:255.255.255.0

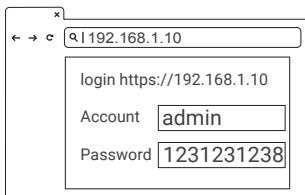

STEP3/ Open a browser and enter IP Address 192.168.1.10 to login into the setup page. Use the following credentials to login.

- Account: admin
- Password: 1231231238

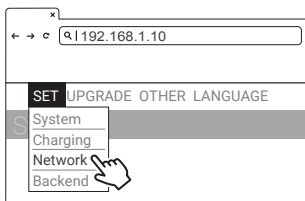

STEP4/ Select "SET" at the top of the webpage to enter the settings page. Select " Network" to enter the network settings page.

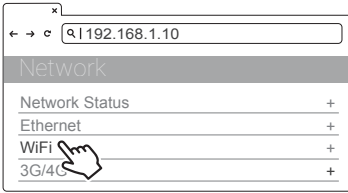

STEP5/ Select the Wi-Fi and 3G/4G module to enter the setting.

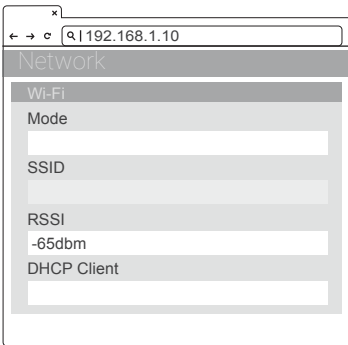

STEP6/ (Wi-Fi Version)

- Make sure the Wi-Fi strength is higher than -65dbm.

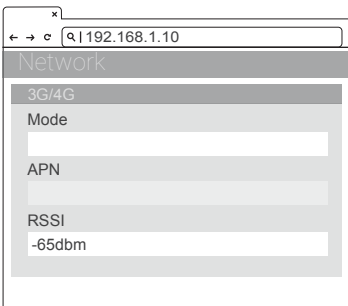

STEP6/ (4G Version)

- Check that the strength of 4G must be higher than -65dbm.

11. Local Load Balance Mode (OFFLINE only)

- When selecting Local Load Balance Mode, there must be a minimum of 2 and a maximum of 4 chargers of the same model, and no more than 5 including the master.
- This mode is only available when there is no internet connection.
- This mode allows chargers in the same local area network (LAN) to communicate with each other via Wi-Fi to achieve the function of smart power distribution. It maximizes the benefits of the charging LAN.

NOTE! This mode cannot be used when connected to the internet, it is only available in offline mod.

NOTE! This mode only supports an output current of 48A or less.

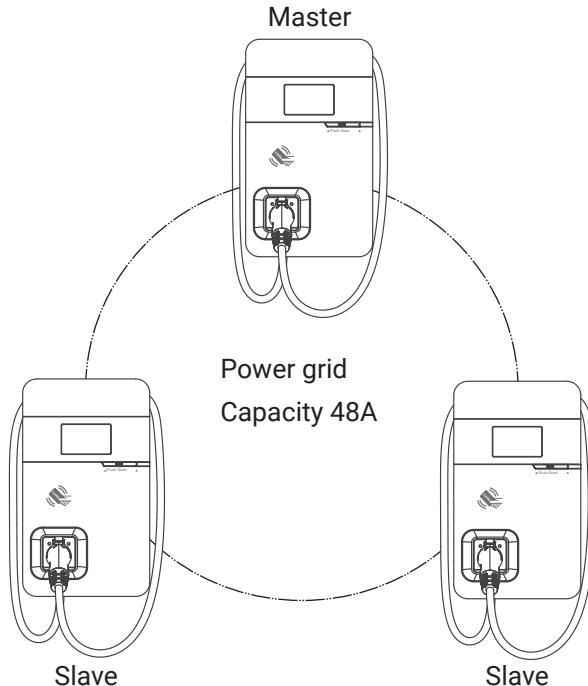

Usage example: LAN containing three devices

Maximum output of devices: 48A

Number of devices: 3.

Example 1:

If there is only one charging device in use in the charging LAN, the master will authorize maximum current output to the device in use, including if only the master is in use.

Example 2:

If there are only two charging devices in use in the charging LAN, the master will authorize the output current to be divided equally between the devices in use.

Therefore, the output current divided equally between the two devices is $(48A \div 2 = 24A \text{ per device})$.

Example 3:

If all three charging devices in the charging LAN are in use, the master will authorize the output current to be divided equally between the used devices.

Therefore, the output current divided equally between the three devices is $(48A \div 3 = 16A \text{ per device})$.

Remarks: The output current also depends on the actual axle load of the electric vehicle.

11.1 Operating procedure

STEP 1

Select master

If the charger still has the default factory settings, it can be used as the master without need for setup, but if other settings have already been completed on the charger, please first refer to Master Setup below.

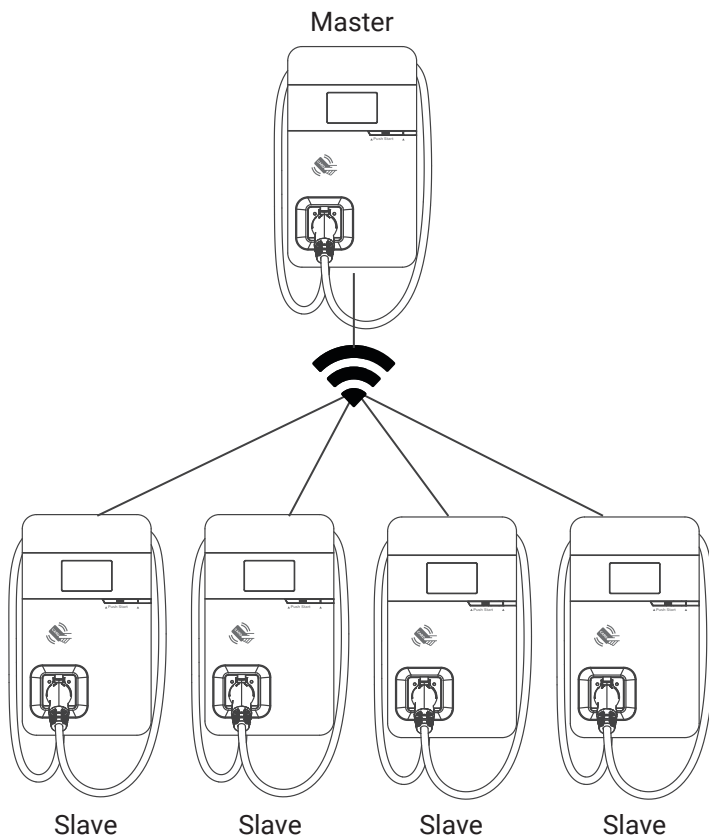

STEP 2

Master Setup

- The rotary switch needs to be set to the default value B

NOTE! If the local mains power system does not support 48A, please adjust according to the size of the local power load. The master will output current according to the set power level. For details on adjustment, refer to section 9.2. Maximum Output Current.

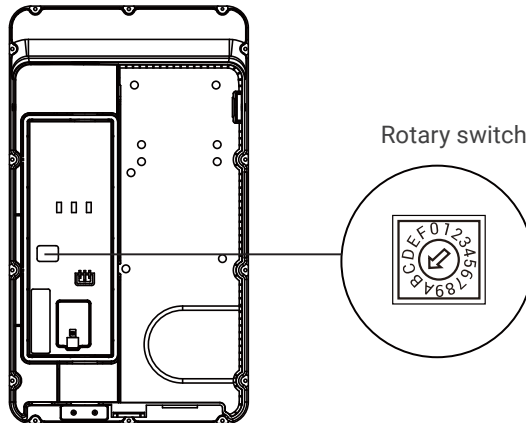

STEP 3

Master Webpage Wi-Fi Setup

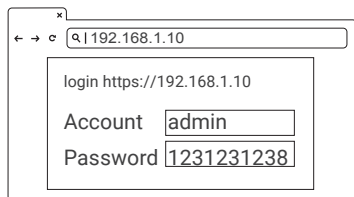

STEP1/ Open a browser and enter the IP address 192.168.1.10 to log into the setup page. Use the following credentials to log in.

- Account: admin
- Password: 1231231238

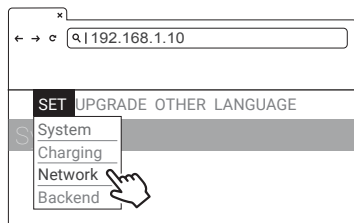

STEP2/ Select "SET" at the top of the webpage to enter the settings page. Select "Network" to enter the network settings page.

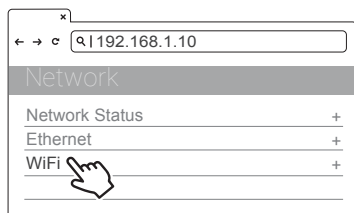

STEP3/ Select Wi-Fi to enter the Wi-Fi Module settings page.

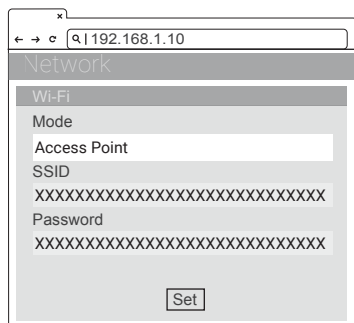

STEP4/ For the "Mode" select "Access Point". The SSID is automatically generated and does not need to be entered.

SSID: Model name + Serial number.

After selecting, press [Set] to save the settings.

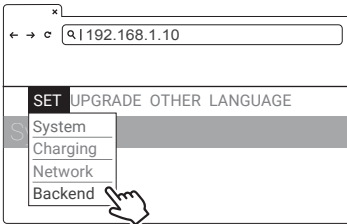

STEP5/Select "SET" at the top of the webpage to enter the settings page. Select "Backend" to enter the network settings page.

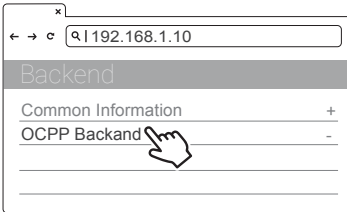

STEP6/ Select OCPP and set the Local load balance to enable.

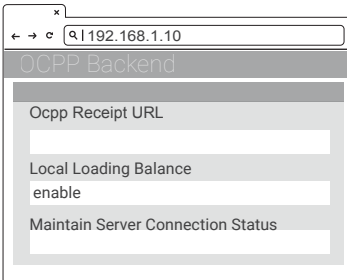

STEP 4

Confirm Model Name and Serial Number of Master

Check the model name and S/N information on the model label located on the side of the device. When setting up connection on slave devices, the master device information will be used as the account password.

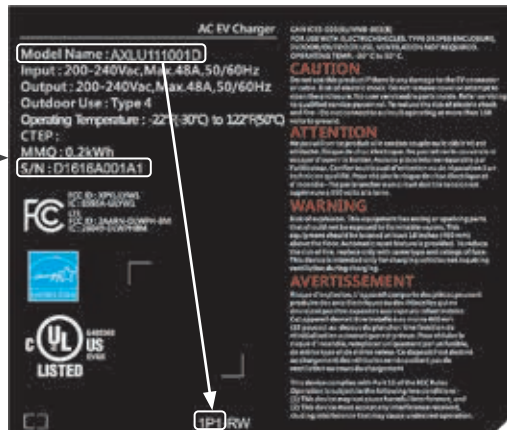
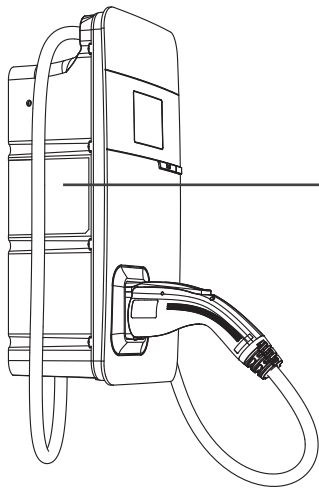

Example:

Slave SSID: AXLU111001D1P1D1616A001A1

Slave password: D1616A001A1AXLU111001D1P1

STEP 5

Select Slave

- Make sure that the number of slaves does not exceed 4
- There must be no walls or obstructions that affect communication between master and slaves
- It is recommended that the master be located in the middle of all the slaves, to ensure the best signal reception

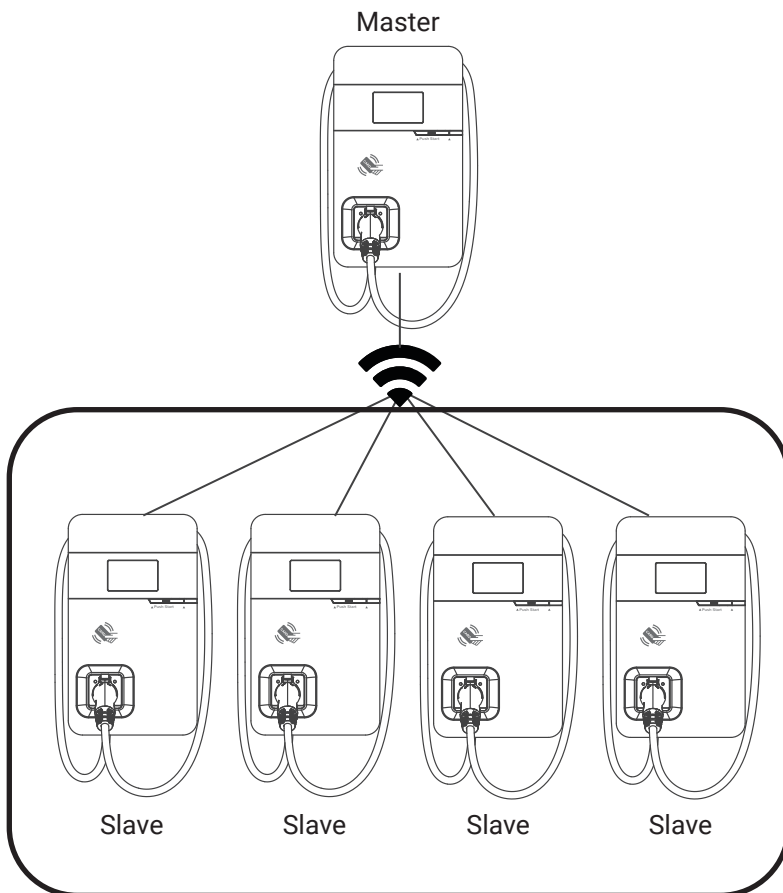

STEP 6

Set Rotary Switch on Slave

Turn the charger around so that the rear side is facing you. Find the rotary switch and rotate it to the F position.

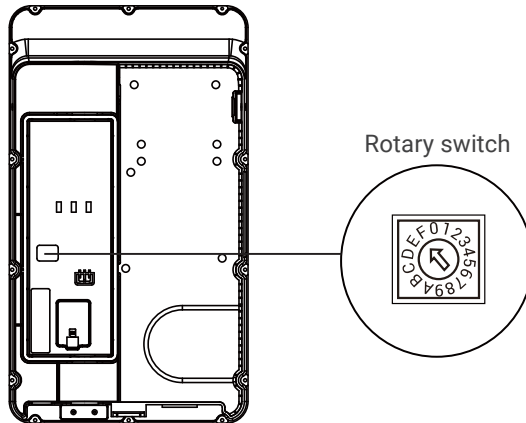

STEP 7

Set Slaves to Connect to Master

This setup procedure connects the slaves to the master to form a local area network (LAN).

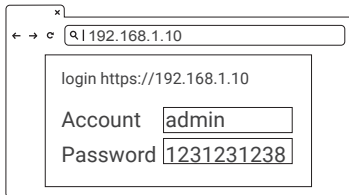

STEP1/ Open a browser and enter the IP address 192.168.1.10 to log into the setup page. Use the following credentials to log in.

- Account: admin
- Password: 1231231238

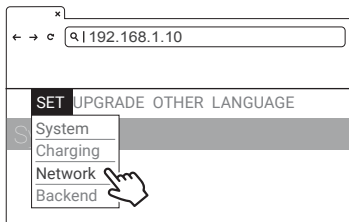

STEP2/ Select "SET" at the top of the webpage to enter the settings page. Select "Network" to enter the network settings page.

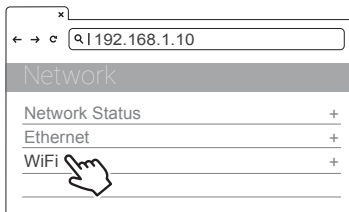

STEP3/ Select Wi-Fi to enter the Wi-Fi Module settings page.

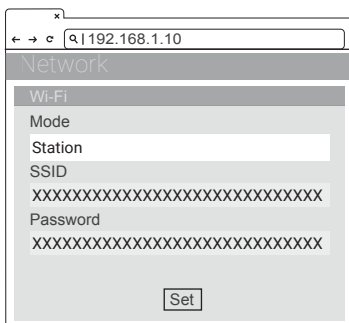

STEP4/ Keep the Wi-Fi Mode set to "Station" and enter the Wi-Fi SSID name and Wi-Fi password. Save the settings by selecting SET.

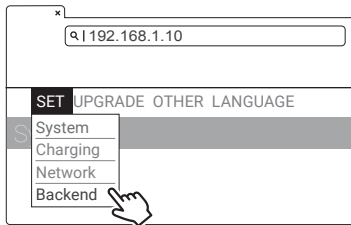

STEP5/Select "SET" at the top of the webpage to enter the settings page. Select "Backend" to enter the network settings page.

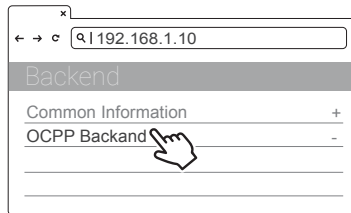

STEP6/ Select OCPP and set the Local load balance to enable.

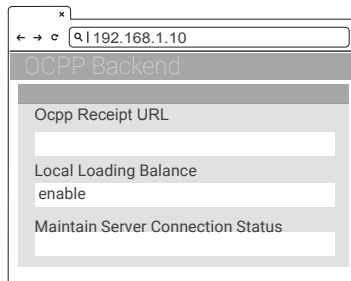

STEP 8

Check Master and Slave Connection Status

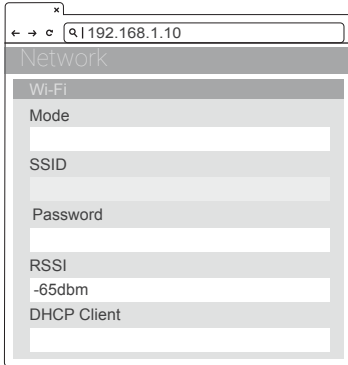

Make sure that the Wi-Fi strength is higher than -65dBm.

STEP 9

Setup Complete

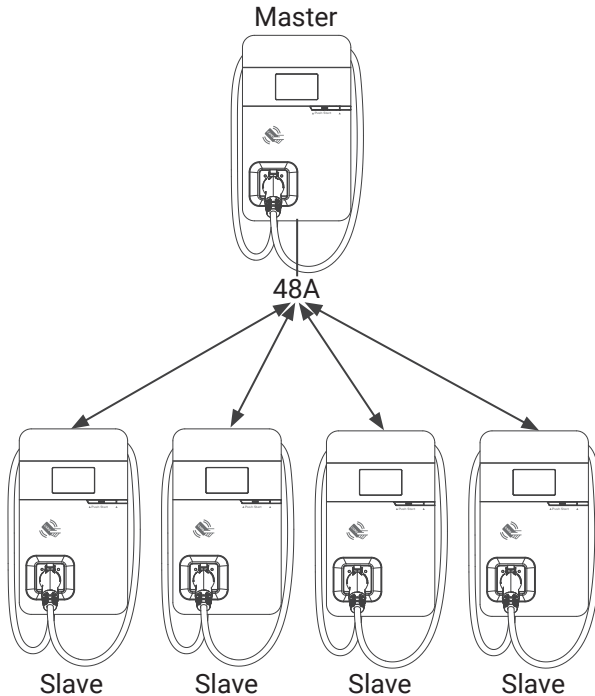

12. Operating Instructions

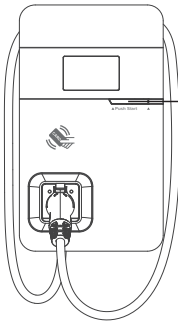

Standby - Green Light

Wait to see the standby light show STEADY GREEN. When the charger is not operated for 120 seconds, it will enter sleep mode.

When the machine is a connected to the backend, the standby light remains GREEN, and it becomes SLEEP GREEN when the machine enters sleep mode.

When the machine is not connected to the backend, the standby light remains YELLOW, and it becomes SLEEP YELLOW when the machine enters sleep mode.

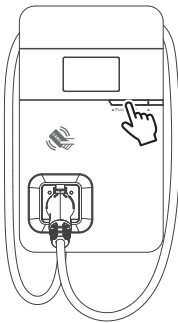

Press the button to wake up the charger.

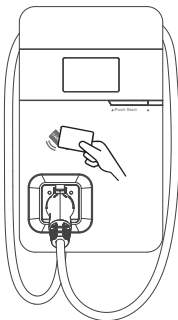

RFID Authorization (Internet Edition)- Green Light Flashing

The green light flashes after RFID is authorized.

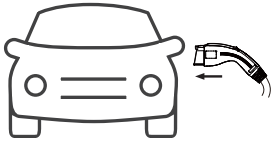

Waiting for Charging - Blue Light

After the vehicle connector is connected to the vehicle inlet, the CHARGE light is constantly lit.

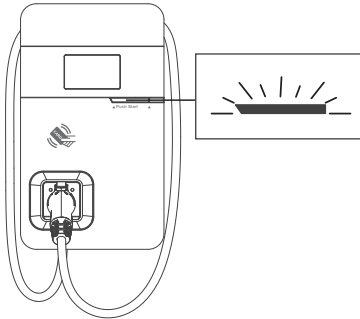

Charging - Blue Light Flashing

The CHARGE light flashes while charging.

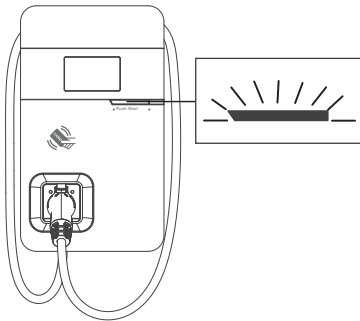

Fault - Red Light

The red light is lit when a fault occurs. Please refer to "8.8 Error and Warning Messages" for detailed information

12.1 Error and Warning Message

Status	Red	Remark
Input OVP	One flash followed by a 3-sec pause	Please measure the input voltage to see if it is higher than 275V
Input UVP	Two flashes followed by a 3-sec pause	Please measure the input voltage to see if it is lower than 160V
Output OCP	Three flashes followed by a 3-sec pause	When the charging current on the car shows overloaded, please disconnect the charging gun and then try to initiate charging again. If the situation recurs, please contact the service personnel of the car maker for identification of problems.
OTP	Four flashes followed by a 3-sec pause	If the temperature of the charger is abnormal, please turn off the charger power to cool down the machine before powering it on again. If the situation recurs, please power off and stop using the machine immediately, then contact customer service.
RCD Abnormal	Five flashes followed by a 3-sec pause	Disengage the charging gun and try the operation again. If the situation recurs, please contact customer service.
Ground Fault ^{*1}	Six flashes followed by a 3-sec pause	Please confirm the grounding status ^{*1}
Control Pilot Fault	Flicker	When communication between the vehicle and charger is abnormal, please disengage the charging gun and operate again. If the situation recurs, please contact customer service.
MCU Self-Test Fail	Constantly Bright	Contact Customer Service
RCD Self-Test Fail	Constantly Bright	Contact Customer Service
Relay Self-Test Fail	Constantly Bright	Contact Customer Service
RCD Abnormal Stop Charging ^{*2}	Constantly Bright	Contact Customer Service ^{*3}
Output OCP Stop Charging ^{*2}	Constantly Bright	Contact Customer Service ^{*3}
OTP Stop Charging	Constantly Bright	Contact Customer Service

- *1 Verify that the Wall Connector is properly grounded. The ground connection must be bonded in the upstream power supply for proper operation. Check all physical connections, including the wire box terminals, electrical panel(s), and wire box. In residential power supplies, check the bond between ground and neutral at the main panel. If connected to a step-down transformer, contact the transformer's manufacturer for direction on how to bond the ground connection.
- *2 Withdrawing and plugging back in the charging gun can exit this stop-charging mode.
- *3 If this stop-charging mode is frequently triggered, please contact customer service for technical solutions.



13. Maintenance and Repair

13.1 Daily Maintenance

Please keep the charger clean and install it in a clean area with low humidity. Do not install it in an environment near the sea, with high levels of oil, humidity or dust.

- Avoid moisture or water in the charger. If water or excess moisture gets into the charger, immediately power off the charger to avoid immediate danger. Proceed to contact the appropriate maintenance personnel before the next use.
- If there is any damage or dirt on the vehicle connector, charging cable, or vehicle connector holder, please contact maintenance personnel immediately.
- Use the charger correctly. Do not hit or press hard on the case. If the case is damaged, please contact a professional technician.
- Avoid placing the charger near to hot objects and in high-temperature locations, and keep it away from dangerous substances such as flammable gases and corrosive materials.
- Do not place external objects or heavy objects on the charger, in order to avoid danger.

13.2 Maintenance Spares

- This product is covered by a two-year parts warranty. If you have a technical issue, contact a dealer and speak to a technical support representative.

13.3 Warranty and Maintenance

- The warranty period for this charger is two years and covers parts only.
- All replacement parts provided during the warranty period will be covered for the remaining balance of the original warranty period, in addition to a 90-day grace period.
- During the warranty period, if any repair or maintenance is performed, an additional 90 days will be added to the original warranty period.
- During the warranty period, if any malfunction is caused by regular use in accordance with the user manual and service instructions (to be determined by dealer), the charger shall be repaired free of charge. Except for the following situations, the charger shall be subject to the above warranty terms:
 1. Inability to provide valid proof of purchase
 2. A product that is out of warranty.
 3. Damage caused to the product due to not following the product service instruction for use, maintenance and storage.
 4. Damage or malfunction caused by a foreign object entering.
 5. Unauthorized repair, disassembly or modification.
 6. Damage caused by force majeure (such as lightning, excessive voltage, earthquake, fire, flood, etc.).
 7. Malfunction and damage caused by other unavoidable external factors. Malfunction and damage caused by improper use of the equipment, such as water or other solutions entering into the equipment.
 8. Malfunction and damage caused by the mains power supply and voltage which is not specified for use with the charger equipment.

13.4 Maintenance History

Product Name _____ Serial No. _____

Product Model _____

Manufacture Date _____ Year _____ Month _____ Day _____

Customer _____

Phone _____

Address _____

1.Maintenance Content

After Service _____ Signature of Customer _____

2.Maintenance Content

After Service _____ Signature of Customer _____

3.Maintenance Content

After Service _____ Signature of Customer _____

4.Maintenance Content

After Service _____ Signature of Customer _____

5.Maintenance Content

After Service _____ Signature of Customer _____



