

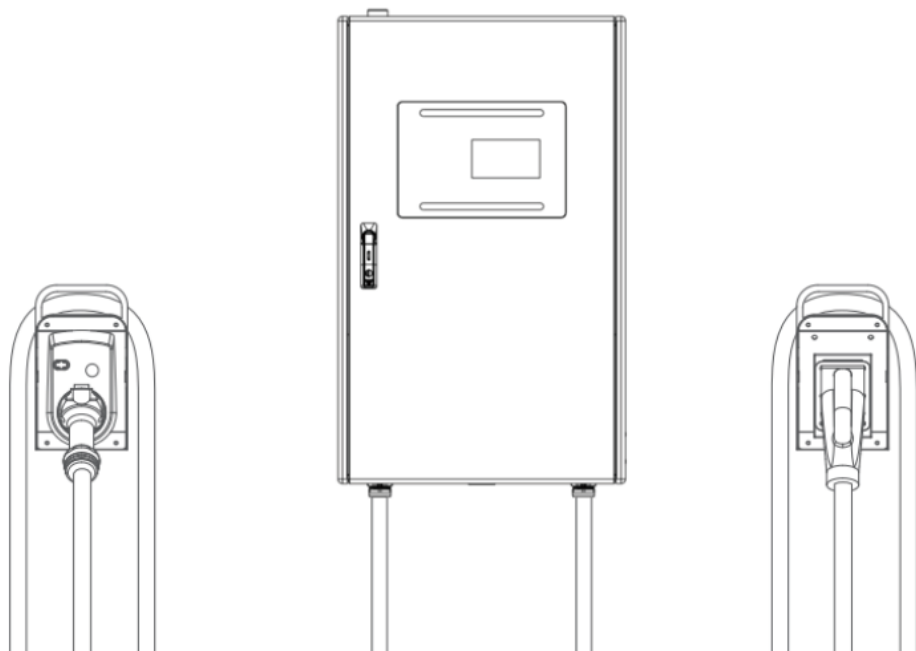

# EVC/D060(D040)

LEVEL 3 60kW & 40 kW  
COMPACT  
EV CHARGER

User Manual & Installation Instructions



[EspenEV.com](http://EspenEV.com)



<b>Introduction</b>	1
<b>Features</b>	1
<b>Application</b>	1
<b>1. Basic User Interface</b>	2
<b>2. Specifications</b>	3
Product specifications	3
LED indication and operating status	4
Dimension	4
Airflow direction	6
<b>3. Installation Instruction</b>	7
Before installation	7
Grounding and safety requirements	7
Unpack the EV Charger	8
Packing list	10
Accessories description	10
Recommended tools for installation and inspection	12
Installation steps	12
Installation inspection and debugging	17
<b>4. Network Settings</b>	18
3G/4G Settings	18
Time setting	23
<b>5. Charging Process</b>	24
System run sequence	24
System run in detail	25
Troubleshooting	30
<b>6. Maintenance</b>	30
General maintenance	30
Replacement kits and accessories	32
<b>7. Limited Product Warranty</b>	32



## Introduction

This DC fast charger is the first choice for powering battery electric vehicles (BEV) and plug-in electric vehicles (PHEV). It is designed for fast charging in public and private locations such as retail and commercial parking spaces, fleet charging, highway service areas, workplaces, residences, etc.

The wall-mounted DC fast charger has the advantage of easy installation. The pedestal-mounted design and plug-in power modules enable flexible and economical installation, suitable for many types of locations. This DC charger also has a network communication function. It can connect with a remote network system to provide electric vehicle drivers with real-time information such as EV Charger location, charging progress and bill information. With a clear user interface, safety certification and excellent waterproof and dustproof design, this DC fast charger is the best choice for outdoor environment.

## Features

- The pedestal-mounted design and pluggable power module make installation easier and more flexible.
- Providing customers with the convenience of start/stop charging control via RFID smart card.
- Adopting the latest DC charging industry standards.
- With IP 54 outdoor protection grade, it can resist the intrusion of solid and liquid in outdoor environment, making the equipment more stable and reliable.
- Provides a high-contrast screen interface and multi-function buttons.
- Surge Protection (Rated to Uc 600Vac 40kW charger and Uc 600Vac 60kW Charger)
- Seismic Performance: Able to withstand the effects of earthquake motions in accordance to ASCE/SEI 7.

## Application

- Public and private parking .
- Community parking.
- Parking lots of hotels, supermarkets and shopping malls .
- Workplace parking lot.
- EV Charger.
- Highway service area.

## EV Charger Body:

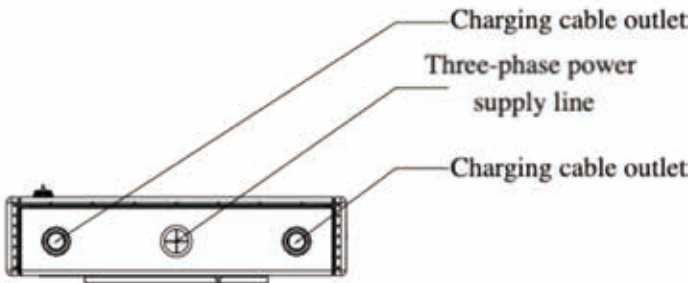
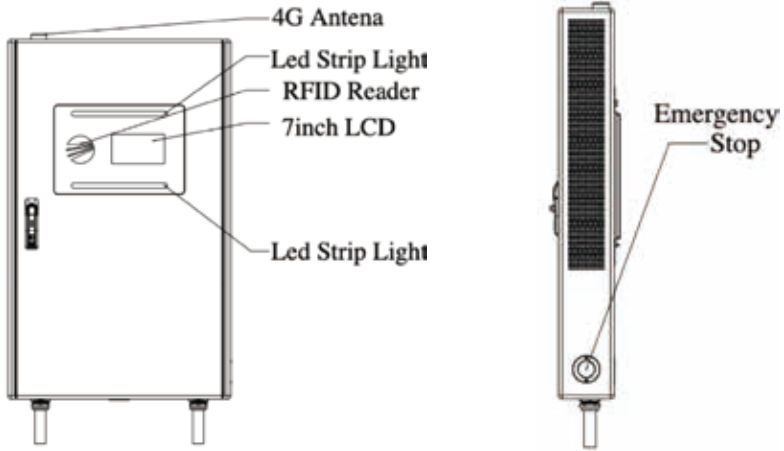

# SPECIFICATIONS



Model Name		EVC/D060P/SN25/EG/G	EVC/D04 0P/SN25/EG/G
AC input	Rated voltage	3Φ480 Vac (+10%, -15%)	3Φ480 Vac (+10%, -15%)
	Input current	73A	49A
	Power distribution	3P+ N +PE (Wye configuration)	3P+ N +PE (Wye configuration)
	Power grid system	TN	TN
	Frequency	45-65 Hz	45-65 Hz
	Power factor	> 0.99	> 0.99
	Efficiency	> 94%	> 94%
DC output	Output voltage range	150-1000Vdc	150-1000Vdc
	Output current range	5-200A	5-125A
	Maximum output power	60kW	40kW
	Voltage accuracy	≤ ±0.5%	≤ ±0.5%
	Current accuracy	≤ ±1%	≤ ±1%
User interface	Display	7-inch LCD display	7-inch LCD display
	User authorization	*Plug and charge *RFID	*Plug and charge *RFID
	Backend support	OCPP 1.6JSON	OCPP 1.6JSON
	Display information	* Charging process and status * EV Charger status information	*Charging process and status *EV Charger status
Electrical Isolation	Isolation between input and output		
Power loss	< 100W		
Communication	External	Ethernet/4G	
	Internal	CAN bus/RS485	
Input protection	OP, POP, UVP, SPD		
Output protection	SCP, OCP, OVP, LVP, OTP, IMD		
Internal protection	OTP, AC contactor detection, DC contactor detection, Fuse detection		
Load management	JSON via OCPP 1.6		
Operation condition	Operating temperature	-30°C to 50°C (-22°F to 122°F)	
	Storage temperature	-40°C to 85°C (-40°F to 185°F)	
	Relative humidity	5%-95% Relative humidity, Non-condensing	
	Altitude	≤2000 m (6560 ft)	
Safety regulation	Safety	UL2202, UL2231-1/-2	
	EMI/EMC	FCC Part 15B	
	Charging port	CCS1&NACS	
Mechanical specification	Dimensions (W x D x H in)	25.6 x 31.5 x 41.3 (Without columns)	
	Weight (typical)	≤176lb	
	Charging cable length	25ft	
	Cooling	Intelligent air cooling	
	Protection level	IP54	
	Shockproof rating	IK10	
Protocol	ISO 15118-1&DIN-70121		

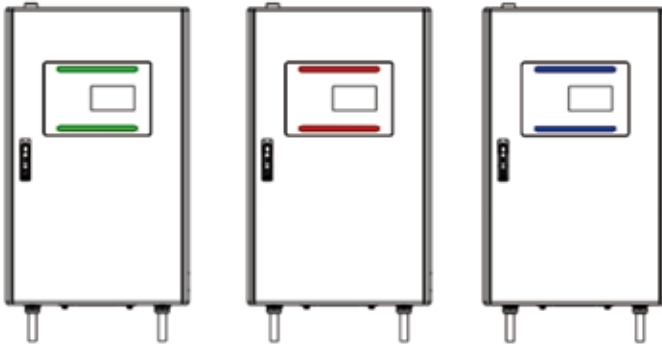

Status/LED	Upper LED/CCS1	Lower LED/NACS
Idle	Green	Green
Fault	Red	Red
Charging	Blue	Blue

## 2.3 Dimension

EV Charger: (Unit: Inch)

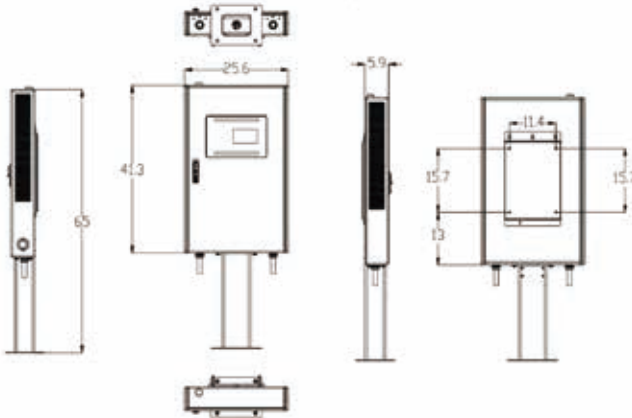

## Wall Mount Bracket: (Unit: Inch)

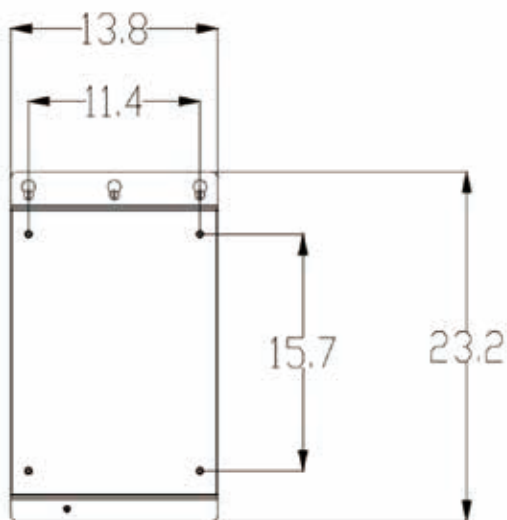

## Pedestal: (Unit: Inch)

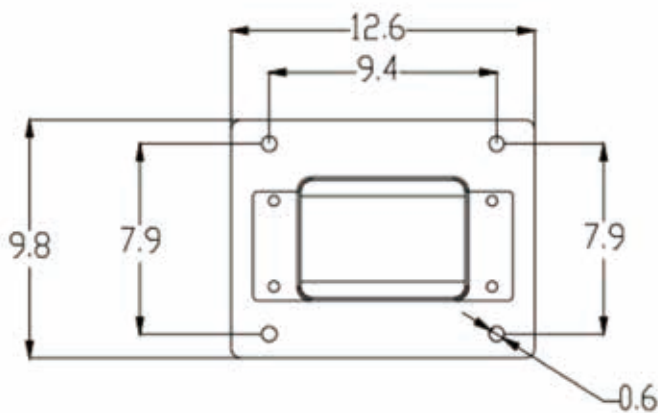

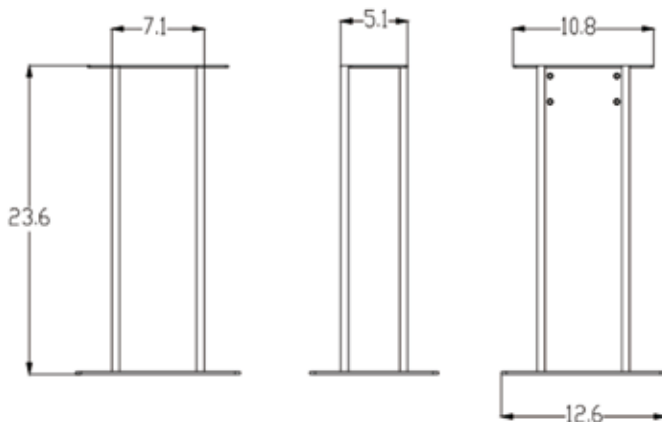

## 2.4 Airflow Direction

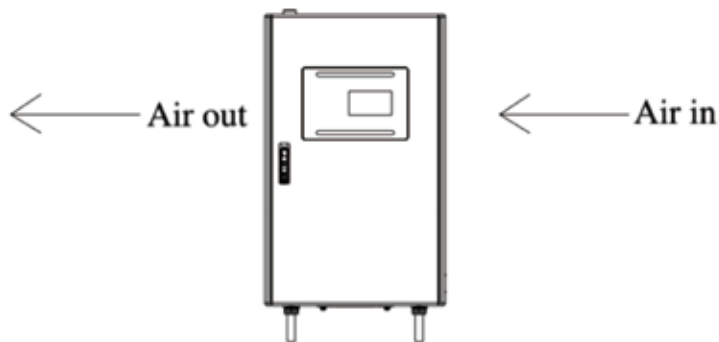

The product should be installed in a well ventilated area and maintain a clearance of at least 23.6 inches from all ventilation openings of the product.





- Please read all instructions before using and installing this product.
- Do not use this product if the power cord or charging cable is damaged in any way.
- Do not use this product if the casing or charging connector is broken, opened or damaged.
- Do not put any tools, materials, fingers, or other body parts into the charging connector or the electric vehicle inlet.
- ⚠️ WARNING: This product should only be installed by a licensed contractor or a licensed technician in compliance with all building codes, electrical codes, and safety standards.
- ⚠️ WARNING: Prior to installation, the product should be inspected by a qualified installer. Following the information in this manual does not in any way relieve the user's responsibility to comply with all applicable codes and safety standards.
- The power supply must be a three-phase Wye configuration with a TN(S) grounding system.
- TN (S) system installation: the PE of the charging equipment is directly connected to the distribution PE, and the neutral line N of the equipment is directly connected to the distribution neutral line N.
- The power supply capacity of a 60kW charger should be higher than 80 kVA, and the power supply capacity of a 40kW charger should be higher than 50 kVA in order to work properly.
- The product should be installed in a well ventilated area and maintain a clearance of at least 23.6 inches from all ventilation openings of the product.
- Sufficient space is required for product installation and maintenance. Please maintain a clearance distance of no less than 28 inches around the product.
- ⓘ Notice: It is recommended to perform a 4G signal strength test when installing the charger. The RSSI (Received Signal Strength Indicator) value should be above -65dBm. If the connection quality is poor, the charging process or data processing may be interrupted.

## 3.2 Grounding And Safety Requirements

- The product must be connected to a grounded, metallic, permanent wiring system. Connections should comply with all applicable electrical codes.
- Keep the power off while installing, repairing or maintaining the EV charger!
- When connecting to the main distribution network, appropriate protection measures should be used.
- Use the appropriate tool for each task.
- ⚠️ NOTE: A disconnect switch for each non-grounded conductor of the AC input should be provided by the contractor or technician in accordance with the National Electrical Code, ANSI/NFPA 70.
- ⚠️ NOTE: Do not use wire extension or a second cable assembly in addition to the cable assembly that connects the electric vehicle to the EVSE.



- Ground connection!
- Always connect the neutral point at the service to a ground wire. If the electrical service does not provide ground connection, a ground stake must be installed nearby. The ground stake must be connected to the ground rod in the main breaker panel and grounded at this point.
- 480Vac (line to line) three-phase.
- Alert! This is a star-connected supply, and the DC charger can be connected to L1, L2 or L3 and neutral. The ground must be connected to neutral at one point only, usually at the circuit breaker panel.

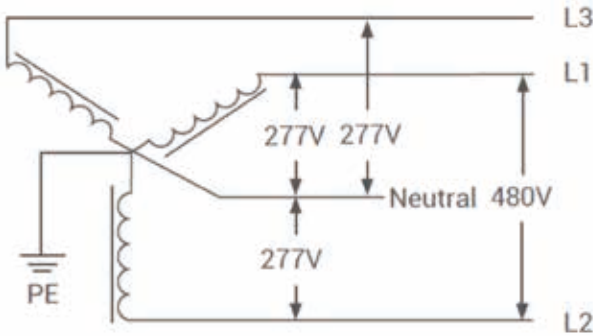

480V Three-Phase Wiring Connection

- ⚠ Danger! Beware of high voltage.
- ⚠ WARNING! Ground connection is crucial.

### 3.3 Unpack The EV Charger

The product is a DC EV Charger. The packaging design has passed the packaging simulation test. If the packaging is damaged by overturning, falling or external impact during transportation, it may cause product damage or defects. If there is any serious damage to the packaging when you receive the goods, please notify the supplier of your findings.

1. Do not refuse delivery/receipt.
  2. Write note on the delivery receipt and check if the box is damaged.
  3. If damage is found, please leave the box in its original packaging and ask the carrier to inspect it immediately within 3 days of delivery.
  4. Contact the manufacturer in time.
- ⚠ WARNING! The charger may weigh more than 176 lbs! Be careful when unpacking

Step 1: Check whether the cover is obviously loose or shaking.

Step 2: Open all the "Hasp locks" and remove the cover, as shown in the figure below.

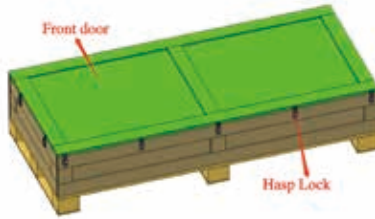

Step 3: Remove the filling paddings, as shown in the picture below.

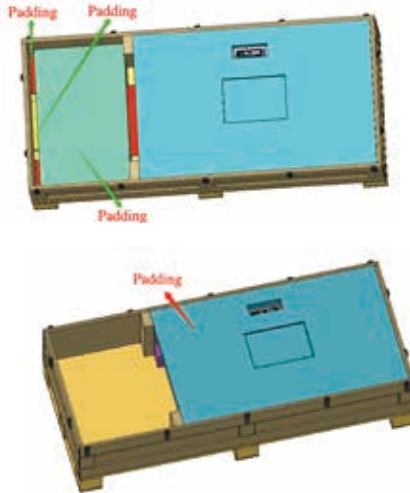

Step 4: Work together to lift the charger body out of the wooden box, as shown in the figure below.

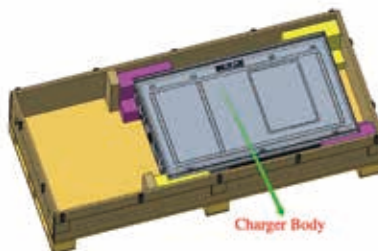

Serial Number	Specifications And Models	Quantity	Remarks
1#	EVSE	1	
2#	User's manual	1	
3#	Copper Lug: SC25-8:2.0mm thick	5	
4#	RFID card	2	
5#	Key	2	
6#	Wall-mounted backplate	1	
7#	Pedestal	1	Specification based on customer requirement
8#	AC / DC Power module	2	
9#	Flat 1-word slotted step screw $\varnothing$ 10X3XM8	3	For wall-mounted backplate
10#	Wedge anchor M8X60	4	For wall-mounted backplate
11#	Hexagon bolt assembly M6X16	1	Anti-theft screw assemblies
12#	Hexagon head bolts and washers assemblies M10X25	4	For fixing the pedestal to the charger body
13#	Sleeve anchor M12X80	4	For attaching the pedestal to the ground or the cement base
14#	Insulating flat gasket	1	Used with Anti-theft screw
15#	GB6170-2000 Hexagon Nut M6 (Galvanized / RoHS) No rust after 48h salt spray test	1	Used with anti-theft screw during pedestal installation

### 3.5 Accessories Description



1#: EVSE



2#: User manual



3#: Copper lug



4#: RFID card



5#: Key

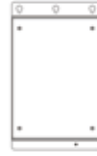

6#: Wall-mounted back plate



7#: Pedestal



8#: AC/DC Power module



9#: Step screw  $\Phi 10 \times 3 \times M8$

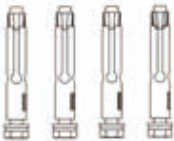

10#: Wedge anchor M8X60



11#: M6X16



12#: M10X25



13#: Sleeve anchor M12X80t



14#: Flat gasket

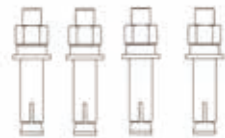

15#: Hexagon nut M6

## 3.6 Recommended Tools For Installation And Inspection

### 3.6.1 Recommended Installation Tools

Type	Model
Socket screwdriver	No. 10 and No. 13
Electrical tape	Black 3/4 inch
AC input cable	60kW recommended cable AWG#4 (21.15 mm <sup>2</sup> ) cable*5 (L1, L2, L3, N, PE) & 40kW recommended cable AWG# 6 (13.26 mm <sup>2</sup> ) cable*5 (L1, L2, L3, N, PE)
Ring terminal crimping pliers	
Hand drill	
Level ruler	
Electric screwdriver (150±10kgf.cm)	
Hexagon wrench	3/16
Ratchet wrench	5/16

### 3.6.2 Recommended Inspection And Debugging Tools

Type	Model
Electric vehicle or EV simulator	Complying with CCS1 / NACS standards
Multi-function instrument	1000V
Current probes	100 A
RFID authorization card	
Door key	
4G Signal quality tester	Recommend

## 3.7 Installation Steps

### Wall Mounting:

1. According to the size of the back plate mounting holes, drill four  $\Phi 0.39$  inch-wide, 3.1 inch-deep holes on the wall. Then use four 10# M8X60 to fix the mounting back plate to the wall. The recommended installation height is shown in the figure below (unit: in) .

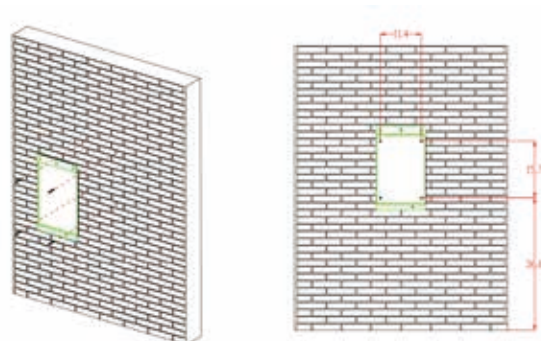

2. Fix three 9#  $\Phi 10 \times 3 \times M8(0.4 \times 0.1 \times 0.3 \text{in})$  step screws into the screw holes on the back of the charger body and tighten it. As shown in the figure below.

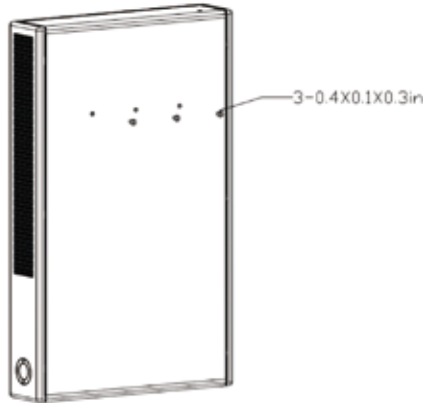

3. Align the three  $\Phi 10 \times 3 \times M8(0.4 \times 0.1 \times 0.3 \text{in})$  step screws with the three gourd shape holes on the back mount panel(6 #) and lock them onto the back mount panel, as shown in the figure below.

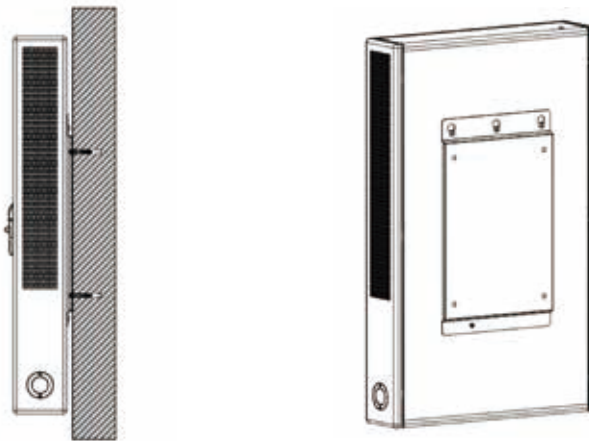

4. From the front of the charger chassis, use the accessory 11# M6X12 hexagon screw and the accessory 14# Flat gasket to fix the charger body and back mount panel. Use one of each, as shown in the figure below .

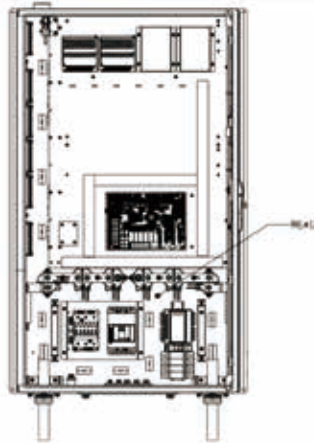

## Pedestal Installation:

1. Use four 12# M10X25 hexagon combination screws to fix the pedestal to the mounting holes at the bottom of the charger body.

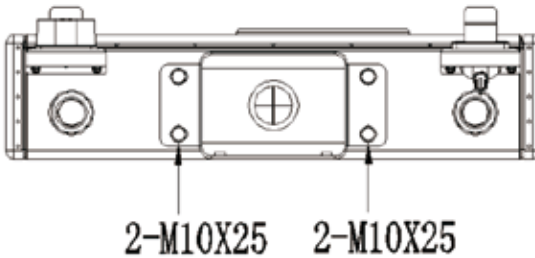

Charger body view from the bottom



2. Drill four  $\Phi 0.55$ in wide, 4in deep holes on the cement floor according to the size of the pedestal installation holes, and then use four 13# M12X80 to fix the pedestal to the floor; or lay the cement foundation in advance, pre-install the pipes, cables and bolts, and fix the EV charger on the embedded bolts.

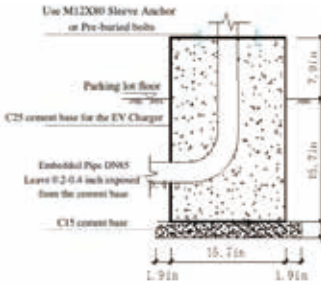

Cement foundation construction

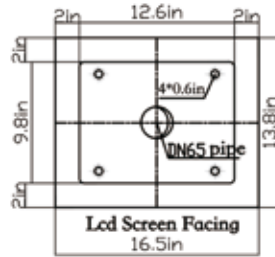

EV Charger foundation plan



The installation is complete

## Power Supply Cable Installation :

Step 1: Lay the EV charger flat on the ground, as shown in the figure below.



Step 2: Press the button under the door handle to pull out the door handle, and rotate the door handle anti-clockwise 90 degrees, as shown in the lower left picture.

Step 3: Pass the pre-buried cables through the cable entry holes at the bottom of the pedestal and the charger body, maintain the appropriate length of each wire, and use cable ties to fix the cables to the grounding copper bus of the EV charger. Next, close the EV charger door, and then stand the EV charger upright and fix it to the pre-buried bolts on the cement foundation, as shown in the lower right picture.

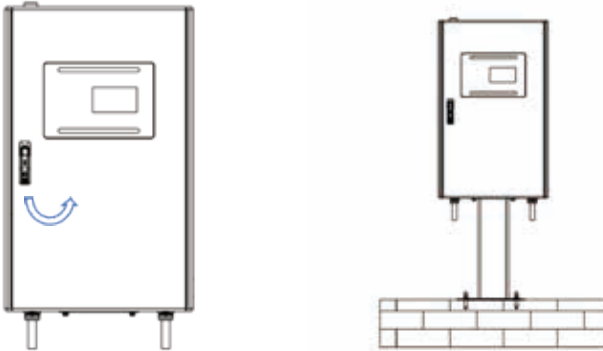

Step 4: After fixing the EV Charger in place with nuts, open the EV Charger door, keep each wire at the required length according to the EV Charger, cut off the excess part, and then crimp it with the 3# accessory. The wiring diagram is shown in the figure below.

Step 5: Use a 3/16 hexagonal wrench to fix the L1, L2, and L3 cables to the circuit breaker using M6 hexagonal bolts. Use a 5/16 wrench to fix the N and PE cables to the copper busbar using M8 screws.

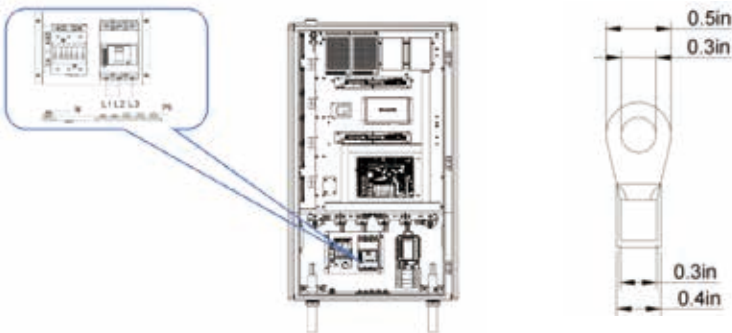

Step 6: Turn the power on and the operation screen will be ready within 30 seconds.



## 3.8 Installation Inspection And Debugging

### 3.8.1 Environment Check List

Project	Status	Remark
Ambient temperature		
Humidity		
Sun visor		Recommended but not required
Awning		Recommended but not required
Air circulation/ventilation		
Dust level		
Anti-shock measures		

### 3.8.2 External Infrastructure Preparation And Inspection

Project	Status	Remark
Input wiring and terminals		
Cabinet keys and locks		
Fixing screws		
No fuse circuit breaker (NFB)		
Residual current device (RCD)		
Input power capacity		
Input power configuration		
Ground resistance		
Grounding system		
Input voltage and frequency		
Network connection and quality		

### 3.8.3 EVSE Inspection - Static (No power)

Project	Status	Remark
Outlook		
Labels and warning signs		
Packing (Accessories) List		
Input line robustness		



### 3.8.4 EVSE Inspection - Connected To Power

Project	Status	Remark
LCD screen on		
Acoustic noise level		
Screen display and features		
Time display		
Network connection quality		
Cooling fan operation and noise		
Status indicator		
EVSE setting		
Engineer mode features		
Hardware and firmware versions		
Remote control and monitoring		
Backend server connection		

### 3.8.5 EVSE Inspection - Charging

Project	Status	Remark
User authorization-RFID		
User authorization - other		
Connection check waiting time		
Readings for each displayed item		
Fully charging test		
Functions of electronic locks		
Engineer mode		
Cooling fan airflow and noise		
Charging records (logs) uploading		
Remote control and monitoring		

### 3.8.6 EVSE Inspection - System Power Button

Project	Status	Remark
Emergency stop button		

## 4. Network Settings

### 4.1 3G/4G Settings

#### 4.1.1 SIM card installation

Step 1: Open the main door of the charger.

Step 2: Unplug the 4G module from the signal adapter board.

Step 3: Insert the 3G/4G Micro SIM card into the tray on the 4g module, making sure the contacts are facing down and the notch is in the upper left corner. Please note that the tray may be damaged if the SIM card is inserted in the wrong direction.

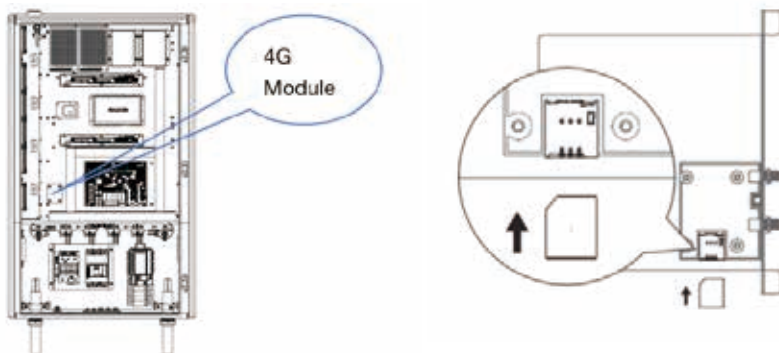

## 4.1.2 Set Up And Enable 3G/4G Connection

Step 1: Please contact your SIM card provider to obtain the APN and password.

Step 2: Open the front door of the EV Charger, which will grant permission to enter the system settings, click the LOGO in the upper left corner on the homepage to enter the system settings, as shown in the picture below.

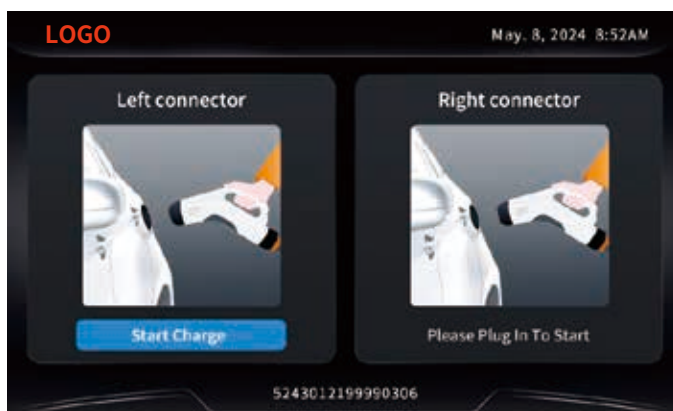

Step 3: Manually click the second option "Parameter Setting" to enter the parameter setting.

Go to page 3; Enter the three parameters "APN Name", "APN User" and "APN Passwd" according to the information provided by the SIM card provider.

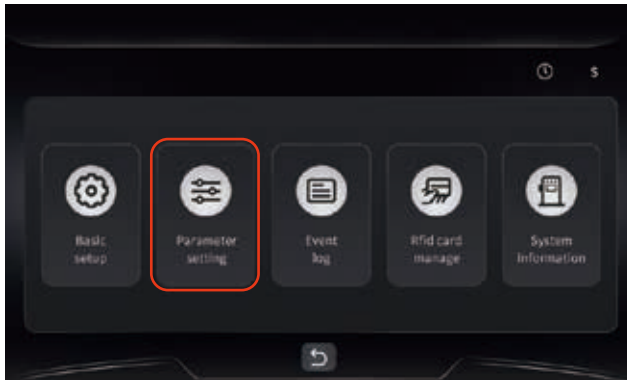

Step 4: Manually click "Previous Page" button to jump to page 2;  
Manually click "Network Type" , select "1" to switch to Ethernet, select "2" to switch to 3G/4G.



Step 5: When completed, exit to the Home page, select the 5th option "System information", and restart system.





## 4.2 Time Setting

Manual setting:

Step 1: Open the front door of the EV Charger, which will grant permission to enter the system settings, click the LOGO in the upper left corner on the homepage to enter the system settings, as shown in the picture below.

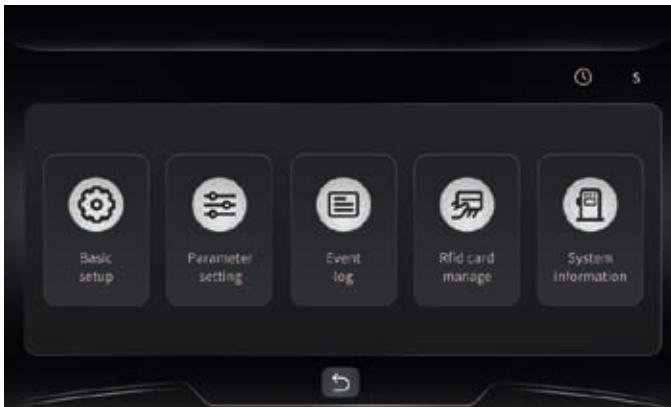
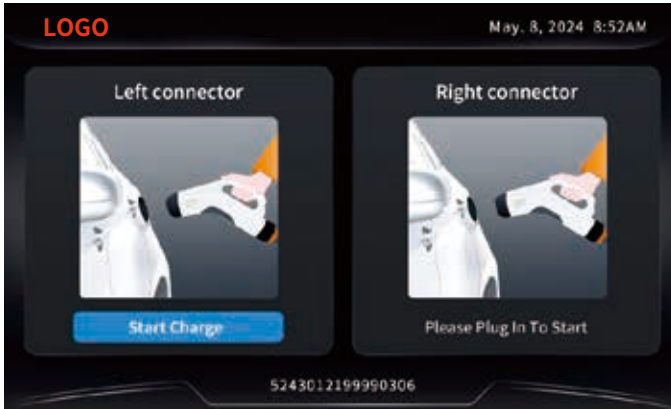

Step 2: Manually click "Basic Setup" to enter the basic setup interface. Select the "Date/Time" on the left and modify it manually; When completed, exit to the Home page, select the 5th option "System information", and restart system. (As shown in 4.1 Step 5).

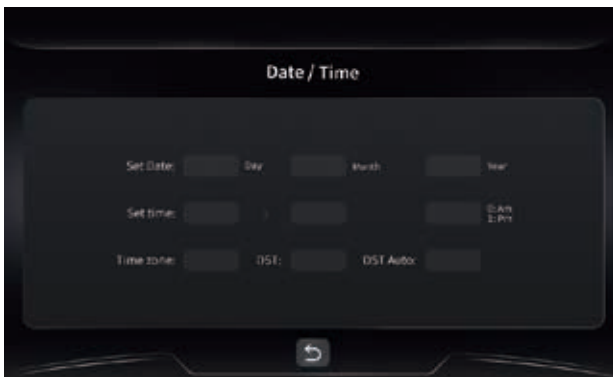

## 5. Charging Process

### 5.1 System Run Sequence

- System initialization.
- User authorization.
- Plug in the DC charging connector.
- Ready to charge.
- Charging.
- Charge termination.
- Alert information.
- Status information.

When the EV Charger is connected to the power supply, the initialization page will appear. The initialization process takes approximately 2 minutes, and then the home page is displayed.



Initialization page

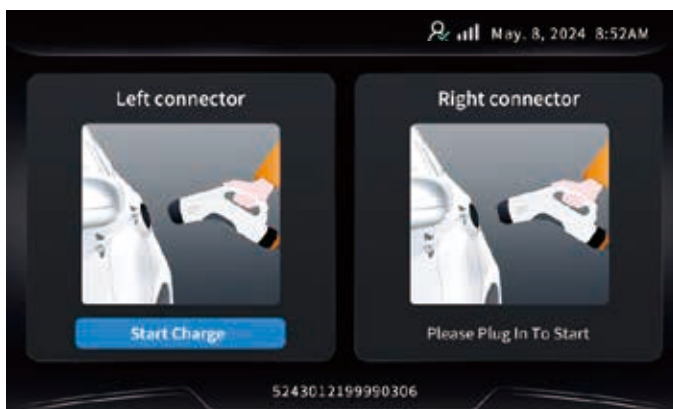

Home

- Platform connection status



Connected; If this logo not displayed: Platform not connected.

- 3G/4G Status



Connect; If this logo not displayed: 4G not connected.

## 5.2.2 User Authorization

- After the system initialization, the screen will stay on the home page, as shown below.
- Use RFID card to authorize the use of EVSE or just plug in and charge if in Plug & Charge mode.

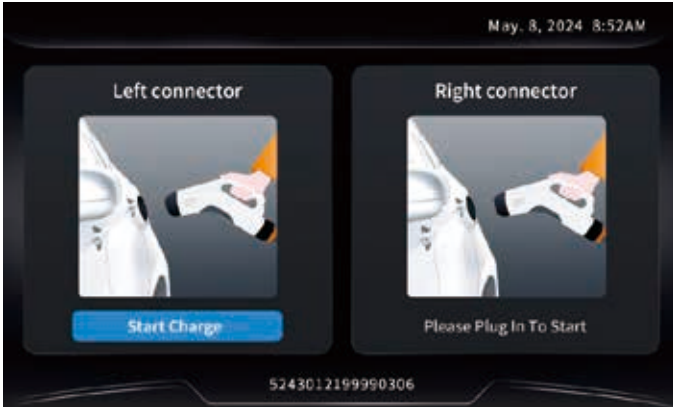

“Start charge”: Charge by swiping RFID card  
“Please plug in to start”: Plug & Charge



Tips for using RFID cards

## 5.2.3 Plug-In Charging Connector

- For plug & Charge, insert the charging connector directly into the electric vehicle charging inlet.
- Start charge option: First insert the gun cable into the electric vehicle charging port and then use an RFID card to authorize .
- Remove the charging connector from the charging cable holder and insert the connector into the electric vehicle charging inlet. The picture below shows the plug-in status.
- To terminate the process, press the left button to return to the home page.



## 5.2.4 Prepare to charge

- Once the authorization and connector insertion are completed, the charger will start communicating with the vehicle and the screen will display the page as shown below.



## 5.2.5 Charging

- After the EV Charger enters the charging preparation stage, the screen will display the charging page as shown below.



Charging in process

## 5.2.6 Charging Termination

- After charging is completed, the charging connector is automatically unlocked and the EV Charger system will display the charging info page, as shown in the picture below.
- Unplug the charging connector from the charging port of the electric vehicle and put the charging connector back into the charging cable holder.
- The screen will return to the home page.

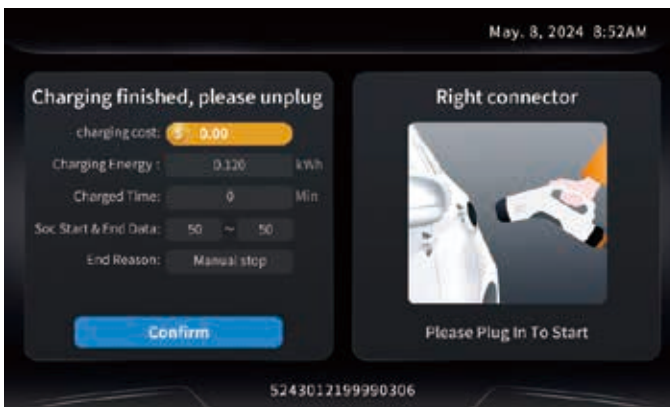

Charging end interface



End of waiting

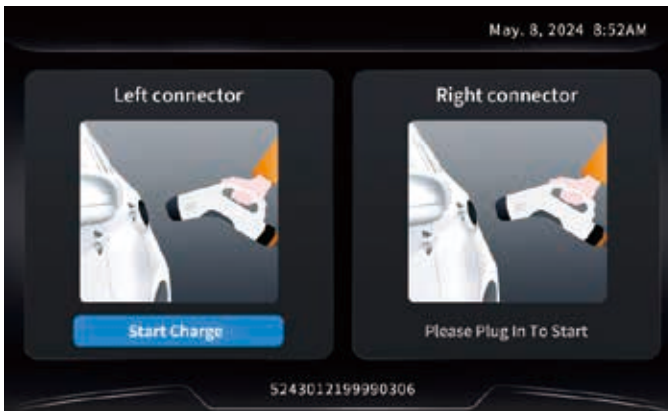

Charging completed and return to home page



## 5.2.7 Status Information

- When there is a problem with the EV Charger or the charging process, a warning will be displayed in the upper right corner of the page, as shown in the figure below.

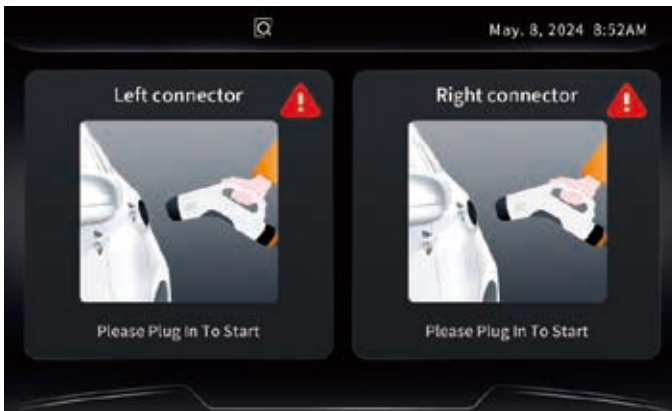

- Click on the warning icon to display the EV Charger status information, as shown in the figure below.



## 5.3 Troubleshooting

- If an error occurs during charging, contact the EVSE provider for further instructions.
- Before remote diagnosis and upgrade, please provide EVSE information, including serial number, model name, status information, fault log and time, and connect EVSE to the Internet.
- If an emergency occurs, press the emergency stop button to stop charging immediately.





## 6. Maintenance

### 6.1 General Maintenance

- DC fast charger is cooled by forced air. Please place the charger in a well-ventilated place and do not block the ventilation openings of the DC fast charger.
- Please clean or replace the air filter regularly to ensure the DC fast charger works properly.
- The casing is made by welding and surface is spray painted. The exterior must be kept clean at all times. If not, it is easy to rust, especially in a corrosion-sensitive environment. Minor rust will not affect the performance of the EV Charger, if the EV Charger is severely rusted during or beyond the warranty period, please contact the local supplier for guidance.
- Clean your DC fast charger at least three times a year and keep the exterior clean at all times.
- Clean the outside of the cabinet with a damp cloth or wet cotton towel. Use only low-pressure tap water and a detergent with a pH value between 6 and 8.
- Do not use a high pressure water gun to clean the EV Charger.
- Do not use cleaning agents containing abrasive ingredients or abrasive tools. Inappropriate cleaning agents may damage the coating, painting, surface, gloss and durability of all external parts.
- If water enters the DC fast charger, please cut off the power supply immediately and contact the DC fast charger supplier for repair.
- Please make sure to put the charging connector back into the charging connector holder after charging to prevent damage.
- If the charging connector, charging cable or charging connector holder is damaged, contact the DC fast charger supplier.
- Properly use a DC fast charger. Do not hit or scratch the casing or screen.
- If the case that casing or screen is broken, cracked, opened, or shows any signs of damage, contact the DC Fast Charger provider.
- ⚠️ **WARNING:** There is a risk of electric shock or injury. Turn off the power at the distribution board or load center before working on the equipment or removing any parts. Do not remove circuit protection devices or any other components before turning off the power. Before performing any maintenance work, disconnect the DC fast charger from the power source to ensure that it is isolated from the AC power source. Failure to do so may result in personal injury or damage to the electrical system and charging unit.

Please note:

- Before turning off the main circuit breaker to begin maintenance, record the status information on the LCD display.
- DC fast charger should only be performed by qualified technicians.
- After opening the front door of the DC fast charger, turn off the main and auxiliary circuit breakers before performing any maintenance work.
- Replace the ventilation filter every six to twelve months.
- Check internal cable connections monthly.
- Please provide EVSE information including serial number, model name, status code, fault log and time, and connect EVSE to the Internet before remote diagnosis and upgrade.



Due to the high output current of the CCS1/2 connector, if there is a problem with the adapter or environmental factors or the adapter is exposed to severe rain, snow, storms or other bad weather, it may cause equipment failure, fire, electric shock, serious injury or death. This warranty does not cover damage caused by accidents with the adapter or damage caused by unauthorized repairs.

## 6.2 Replacement Kits And Accessories

The following replacement kits and accessories are available for DC EVSE.

Replacement Kit List
7-inch LCD display
CCS1/ NACS ( 200A ) DC charging connector and 7.5M charging cable
Charging cable holder
Emergency stop button
Front door
AC/DC charging module
12V vehicle auxiliary power supply
Control and supervision Unit (CSU)
Surge protection device (SPD)
DC Fan
RFID card reader
Door key

## 7. Limited Product Warranty

The charger has a standard limited two-year warranty.

The use of replacement and repair parts from manufacturers other than repair parts is permitted only with authorization from Espan.

The charger body is made of welding process and surface spray paint. The exterior must be kept clean at all times. If not, it is easy to rust, especially in a corrosion-sensitive environment. Minor rust will not affect the performance of the EV Charger, if the EV Charger is severely rusted during or beyond the warranty period, please contact the local supplier for guidance.

The warranty does not cover:

- Damage or unavailability of lighting due to earthquake, power surge, fire, or disaster,
- Damage, pests, abuse, accident, misuse, neglect or failure to maintain control, or events occurring under abnormal operating conditions.
- Cosmetic or surface defects, dents, marks or scratches resulting from use.
- Parts separated from the product, auxiliary equipment and consumables, such as door keys, RFID cards, quick guides, air filters, fuses, cables, wires and connectors.



- The following reasons should be listed below: The product has been altered, modified or disassembled without the written authorization of the supplier.
- Damage caused by failure to observe safety regulations related to the correct use of the product.
- Failure to strictly follow the documentation requirements for installation or operation, including but not limited to failure to ensure adequate ventilation of the product as described in the supplier's installation instructions.
- If a product is defective and a valid claim is received during the warranty period, Supplier will, at its sole discretion, take the following exclusive remedies to the extent permitted by law:
  - Repair product defects free of charge using new or refurbished parts.
  - Replace your product with a new or refurbished product that is functionally equivalent to the original product.
- The warranty period for any remediated hardware product is the remainder of the original warranty period or 90 days from the date of delivery to the customer, whichever is longer. To obtain the above remedies, you must contact the supplier within the warranty period and provide the model, serial number, proof of purchase and date of purchase.
- This warranty does not cover damage to the adapter caused by accident or damage caused by unauthorized repairs.



[EspenEV.com](http://EspenEV.com)