

EVC/A32

Level 2 EV Charger

Installation Manual and User Guide

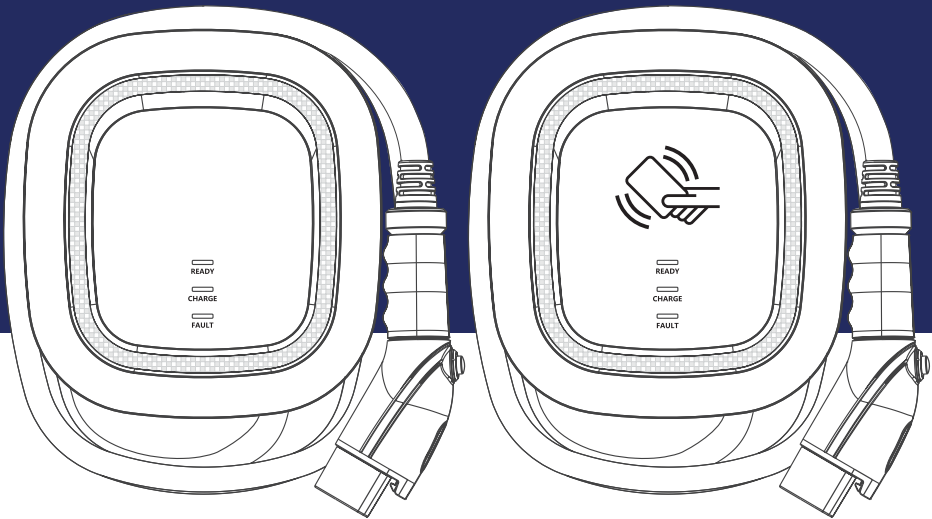

Non-Networking Edition

Networking Edition



IP55



Authorization



Management



Repairable



Outdoors

CONTENT

1. Important Safety Instructions	1
2. Interface	3
2.1 Non-Networking Edition	3
2.2 Networking Edition	4
3. Dimensions	5
3.1 Main Size of Charger	5
3.2 Wall-Mount Bracket	5
4. Specification	6
5. Design Standard	7
6. Status Description of the Charger	8
7. Installation Instructions	10
7.1 Packing List	12
7.2 Tools and Materials Required	13
7.3 Wall-Mount Bracket Installation Requirements	13
7.4 AW Installation Requirements	13
7.5 Installation Steps	14
7.6 Wall-Mount Bracket Installation	17
8. Operating Instructions	19
8.1 Operating Procedures	19
8.2 Operating Steps – Non-Networking Edition	19
8.3 Operating Steps – Networking Edition	20
8.4 Time setting (Networking, Wi-Fi and 4G Editions)	21
8.5 Wi-Fi Setup (for the optional Wi-Fi Edition)	23
8.6 4G Setup (for the optional 4G Edition)	24
8.7 Re-checking the Wi-Fi and 4G Signal Strength on Power-Up.	25
8.8 Error and Warning Message	27
9. Federal Communication Commission Interference Statement ...	28
10. Industry Canada statement	29
11. Maintenance and Repair	31
11.1 Daily Maintenance	31
11.2 Maintenance Spares	31
11.3 Warranty and Maintenance	31
11.4 Maintenance History	33

1. Important Safety Instructions

Please read all Important Safety Instructions as well as charging instructions in your vehicle owner's manual before attempting to charge your electric vehicle. Failure to do so can result in death or severe injury. Save this user manual for future reference. There are many safety features built into the charger. Read all the safety information and warnings in this manual to be avoid any risks or hazards and risks associated with using this charger.



Warning

When using electric products, basic precautions should always be followed. This manual contains important instructions, including the following, that must be followed during installation, operation and maintenance.

- Do not install or use the charger near flammable, explosive, corrosive, or combustible materials, chemicals, or vapors.
- Turn off the input power of the charger before performing any maintenance to the charger.
- The device is designed only for vehicles that are compatible with the SAE J1772 Level 2 charging standard.
- Do not use the charger if it is defective, appears cracked, frayed, broken or damaged.
- Do not attempt to open, disassemble, repair, tamper with, or modify the charger. Contact our Customer Service department if you have any questions or require any parts replacements or repairs.
- Do not use the charger when you are, the vehicle is, or the charger is exposed to severe rain, snow, or other severe weather.
- When transporting the charger, handle it with care and do not drag or step on the device.
- Do not touch the charging connector terminal with any sharp metallic objects to preventing damage.
- Do not forcefully pull the charging cable, damage it with sharp objects, put fingers, or insert foreign objects into any part of the charging connector.
- Risk of explosion. This device has arcing or sparking parts that should



not be exposed to flammable vapors.

- Risk of electric shock. Do not remove cover or attempt to open the enclosure of this device. There are no user-serviceable parts inside. Contact a qualified service company if you require any service repairs.
- To reduce the risk of fire, this charger should only be connected to circuit overcurrent protection in accordance with the National Electrical Code, ANSI/NFPA 70, and the Canadian Electrical Code, Part I, C22.1.
- This charger should be installed, adjusted, and serviced by a qualified electrician or a person familiar with the construction and operation of this type of charger and the dangers involved. Failure to observe this precaution could result in damage to the charger or even severe injury or death.
- Incorrect installation and testing of the charger could potentially damage either the vehicle's battery and the charger. This type of damage is not covered by our warranty policy.
- Ensure that the charging cable is well-positioned during the charging process to avoid the cable getting stepped on, tripped over, or subjected to damage or stress.
- Do not use this charger with a frayed charging cable with damaged insulation or any other sign of damage.
- Ensure the wire type, diameter, current rating, and temperature rating comply with the local electrical standards and requirements in your local area.
- Before starting the installation, turn off all power.

2. Interface

2.1 Non-Networking Edition

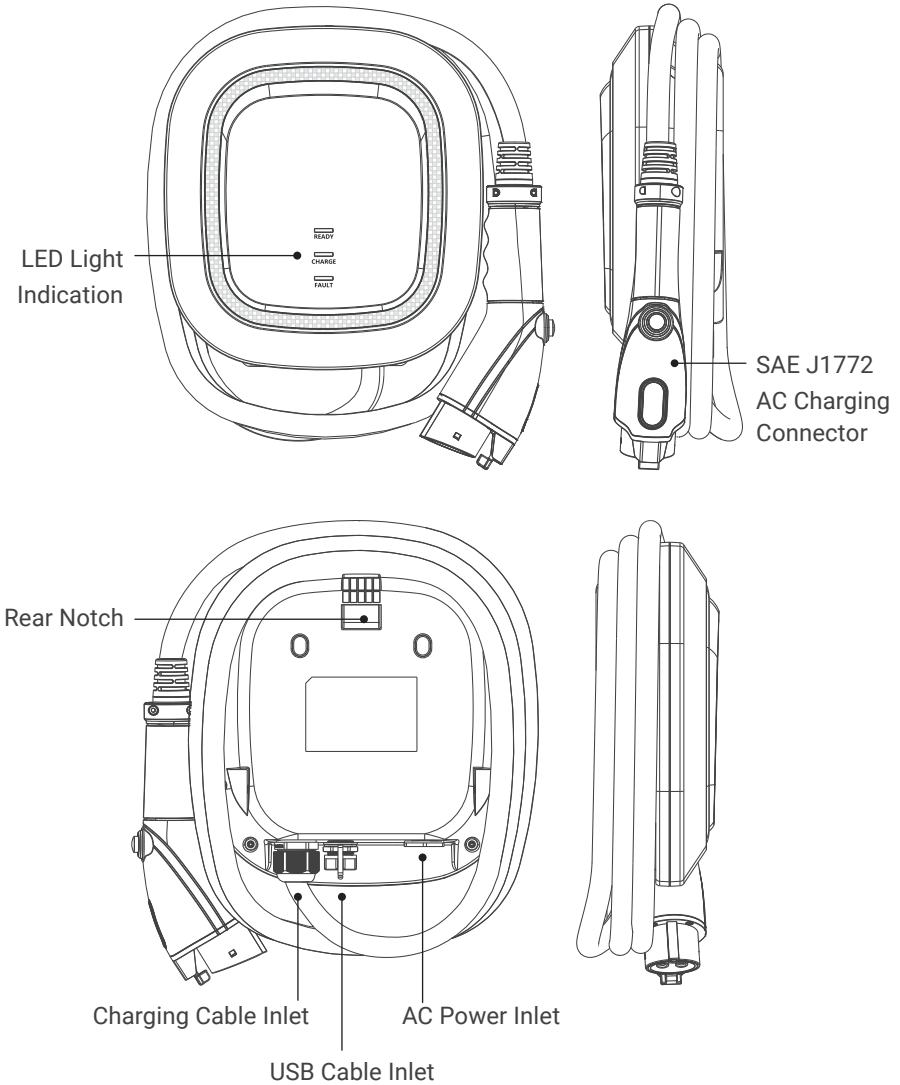

2.2 Networking Edition

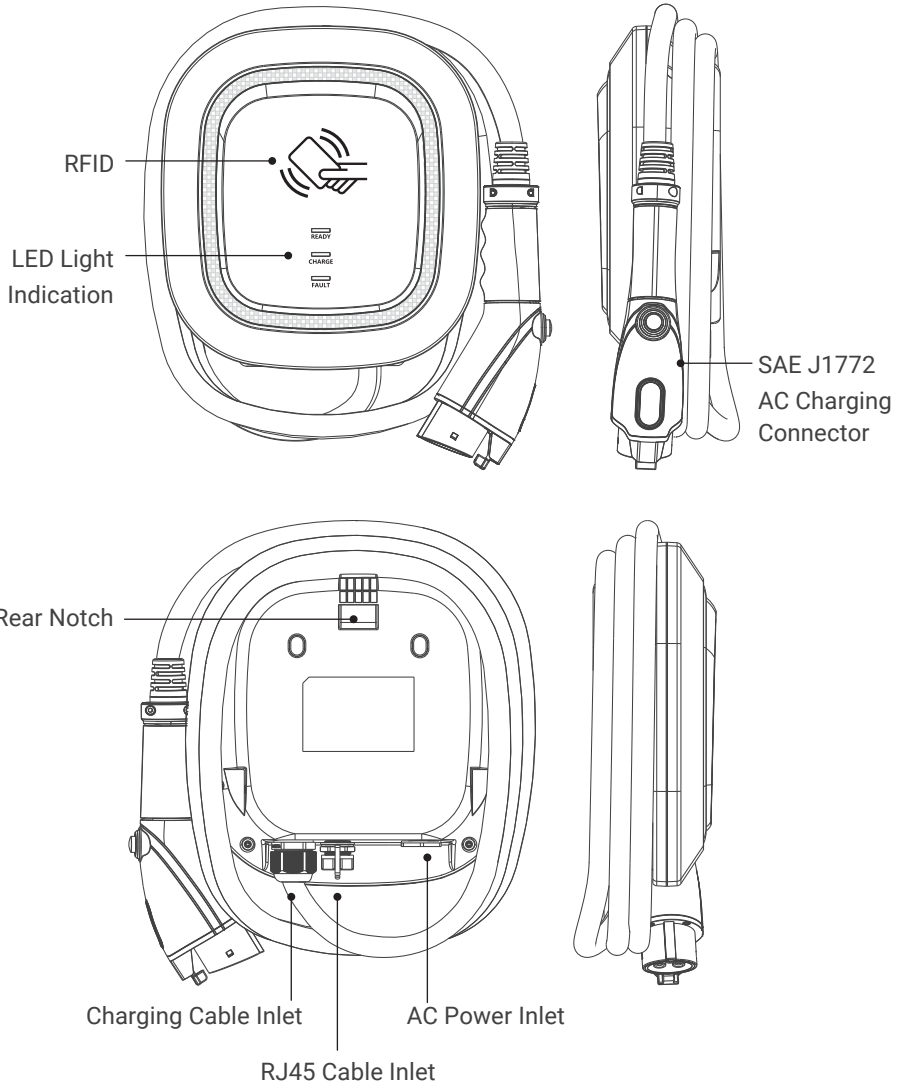

3. Dimensions (unit:mm)

3.1 Main Size of Charger

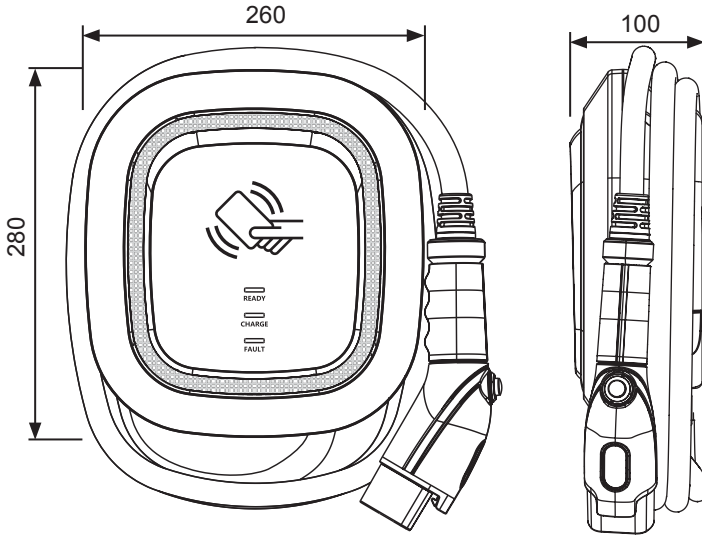

3.2 Wall-Mount Bracket

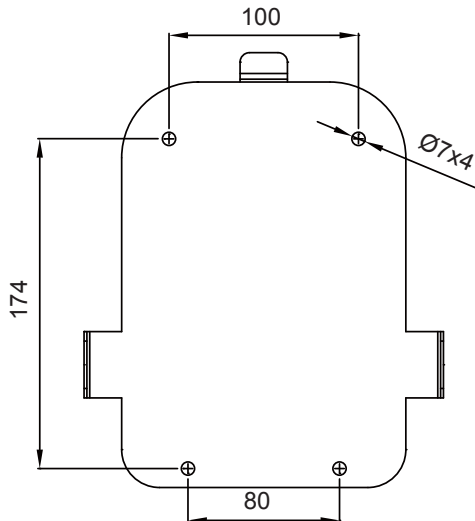

4. Specification

Model Name	EVC/A32 - UL Version
Rated Input Voltage	200-240 VAC / Single Phase
Rated Output Current	Single Phase / 32A
AC Power Frequency	50/60 Hz
Input Protection	UVP, OVP, RCD, SPD, Ground Fault Protection
Output Protection	OCP, OTP, Control Pilot Fault Protection
Output Interface	SAE J1772 AC Charging Connector
Storage Temperature	-40°C to +70°C
Operation Temperature	-30°C to +50°C
Relative Operation Humidity	95%RH Maximum
Relative Storage Humidity	95%RH Maximum
RFID Authorization	Networking Version or Wi-Fi Version or 4G Version
RJ45 Cable Inlet ^{*1}	10M/100M Base-T
Wi-Fi Function ^{*2}	802.11 b/g/n
2G/3G/4G Function ^{*3}	LTE, UMTS/HSPA(+), GSM/GPRS/EDGE
Cable Length	5M (From charger's body to lower edge of charging connector)
Protection Level	NEMA TYPE 3R
Installation Type	Wall-Mount
Altitude	≤ 2000 m
Weight	4±0.5kg
Dimensions	260mm x 280mm x 100mm
Status Indication	Red, Green, Blue LED

*1 Networking Version or Wi-Fi Version or 4G Version

*2 Wi-Fi Version

*3 4G Version

5. Design Standard

Safety standards
UL2594: Electric Vehicle Supply Equipment
UL 2231-1: Personnel Protection Systems for Electric Vehicle (EV) Supply Circuits: General Requirements
UL 2231-2: Personnel Protection Systems for Electric Vehicle (EV) Supply Circuits: Particular Requirements for Protection Devices for Use in Charging Systems
UL 2251: Plugs, Receptacles and Couplers for Electric Vehicles
UL 62: Flexible Cords and Cables
UL 991: Tests for Safety-Related Controls Employing Solid-State Devices
UL 1998: Software in Programmable Components
NFPA 70 Article 625: National Electrical Code, Electric Vehicle Charging System
UL840 (Clearance and Creepage)

6. Status Description of the Charger Indication Lights

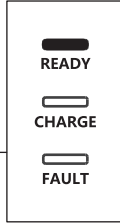
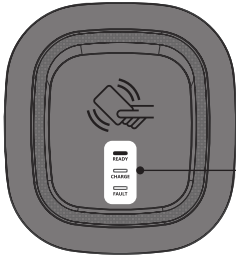

Standby - Green Light

The **READY** light stays lit during standby mode.

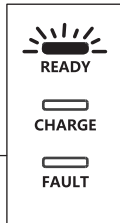
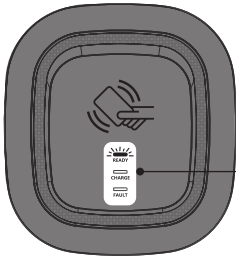

RFID Authorization (Internet Edition)- Green Light Flashing

The Green light is flashing after the RFID is authorized.

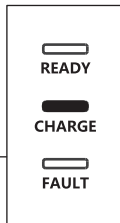
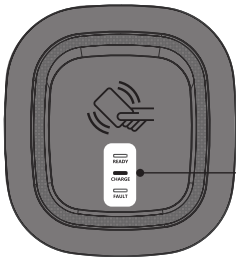

Waiting for Charging - Blue Light

After the vehicle connector is connected to the vehicle inlet, the **CHARGE** light is constantly lit.

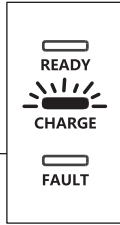

Charging - Blue Light Flashing

The CHARGE light flashes while charging.

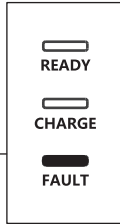

Fault - Red Light

The red light is lit during fault. Please refer to "8.4 Error and Warning Messages" for detailed information.

7. Installation Instructions

Safety Requirements

- Read this user manual thoroughly and make sure to review all local building and electrical codes are reviewed before installing the AC charger.
- A qualified technician should install the AC charger according to the user manual and local safety regulations.
- Use appropriate protection when connecting to the main power distribution cable.
- Type B, C or D breaker with the a rating current of 40Amp should be installed in the upstream AC distribution box.
- Disconnect switch for each ungrounded conductor of AC input shall be provided by others in accordance with the National Electric Code, ANSI/NFPA 70.
- Verify that the Wall Connector is properly grounded. The Ground connection must be bonded in the upstream power supply for proper operation. Check all physical connections, including the wirebox terminals, electrical panel(s), and junction boxes. In residential power supplies, check the bond between Ground and neutral at the main panel. If connected to a step- down transformer, contact the transformer's manufacturer for direction on how to bond the ground connection.

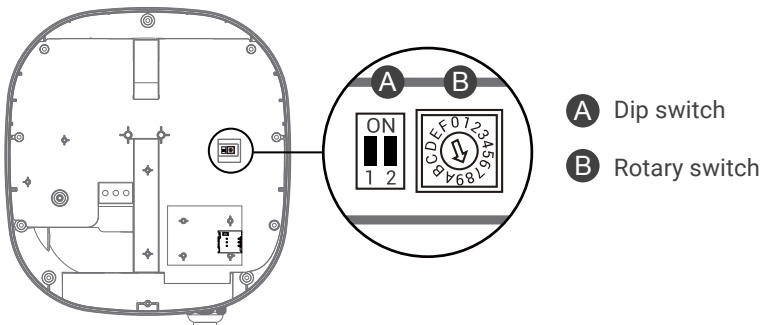

Power Grid Connection and Grounding Type

- This AC charger supports different power grid connections and grounding types. You can configure through the setting dip switch. Setting methods are shown below.
- Before setting the dip switch, make sure the input power is turned OFF.
- Use a non-conductive object to set the dip switch.

	Switch 1 (Power Grid Type)	Switch 2 (Grounding System)
ON	LN	IT
OFF	LL	TT-TN

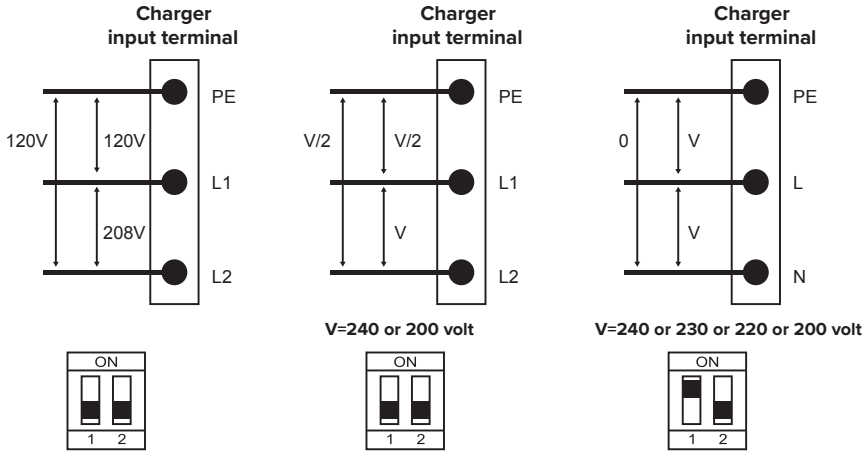

- * Note 1: The default value in North America and Japan is (LL / TT-TN).
- * Note 2: The default value for other regions is (LN / TT-TN).
- * Note 3: If it is not the above standard grid type, please contact our technical staff for assistance and confirmation.

Maximum Output Current

This AC charger can support different maximum output current through the setting rotary switch. Setting methods are shown below

- Before setting the rotary switch, make sure the input power is turned OFF.
- Use a non-conductive object to set the rotary switch.

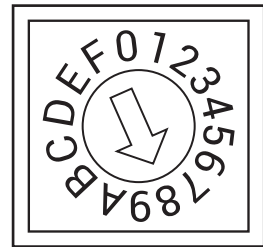

Switch Setting Number	0	1	2	3	4	5	6	7	8,9	A	B~E	F
Maximum Output Current	Test Mode	6A	8A	10A	13A	16A	20A	25A	32A	30A	Invalid Setting	Slave Mode

- * Note 4: The default value for Japan is 30A.
- * Note 5: The default value in other countries is 32A.

7.1 Packing List

1

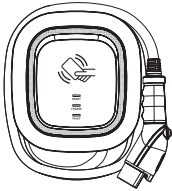

2

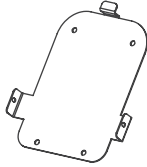

3



4



5



6



7



8



9 RFID Version



10



No.	Product Name	Quantity	Note
1	AC Charger (With Charging Cable)	1	
2	Wall-Mount Bracket	1	
3	User Manual	1	
4	Product Certification	1	
5	Expansion Screw	4	
6	M6 Self-Tapping Screws	4	
7	M4 Screw	2	
8	M25 Cable Gland	1	
9	RFID Card (RFID Version Only)	2	
10	Needle Terminal	3	

7.2 Tools and Materials Required

Tools required before installing the charger onto the Wall-Mount Bracket are:

- Wire stripper
- Crimpers for terminals
- Phillips screwdriver for M4 ~ M6
- Slotted screwdriver for 4~5.5MM
- Voltmeter or digital multimeter (for measuring AC voltage at the installation site)
- The inserting cable should meet the best waterproof performance. It is recommended to use a 3 core / 8AWG or 10mm² cable (XLPE or equivalent cable) to pull the cable from the distribution box. The maximum outer diameter of the cable should be 13mm ~ 18mm.
- Level ruler
- Pencil or marker
- Machine drill

7.3 Wall-Mount Bracket Installation Requirements

Before installing the wall-mount bracket, you should confirm that the loading capacity of the wall can reach a weight of 36 kg. When installing on a cement wall, you can use the included expansion screw to install the bracket and use a cement drill to drill holes on the cement wall (Ø8mm) following the hole spacing in accordance with 3.2.

When installing on a wooden wall, you can directly use the included M6 self-tapping screws to install the wall-mount bracket and use the wall-mount backplane to lock and install on the wall directly.

7.4 AW Installation Requirements

To select the best location and position to install the wall-mount unit, you should first determine the parking position of the vehicle to ensure the charging connector can be easily inserted into the vehicle charging inlet.

The wall-mount unit should be located:

- In a well-ventilated area. Avoid installing in closed boxes or near the exothermic chargers.
- 1.2 meters or 4 feet above the floor.
- 250mm (10inches) from any obstacles to allow cables to loop around the wires and related maintenance.
- If in an enclosed garage, on the side of vehicle charging inlet.

7.5 Installation Steps

Warning for Wi-Fi and 4G versions:

Due to different congenital environments, it is recommended to first conduct Wi-Fi and 4G module network signal tests before finalizing your settings. It is recommended that the RSSI (Received Signal Strength Indication) value should be higher than -65dBm. If it is lower than this value, it may result in a weak Wi-Fi or 4G connection or disconnection due to external interference in the area.

STEP 1

Use screwdriver to loosen the 9 fixed screws on the rear of charger, then remove the front cover.

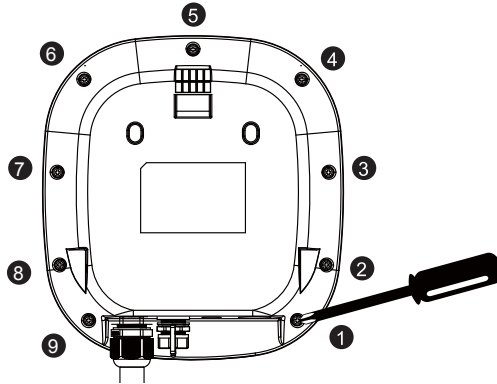

STEP 2

Connect and Lock the M25 waterproof gland Part1 and Part2 (including the washer) to the mounting holes as shown below.

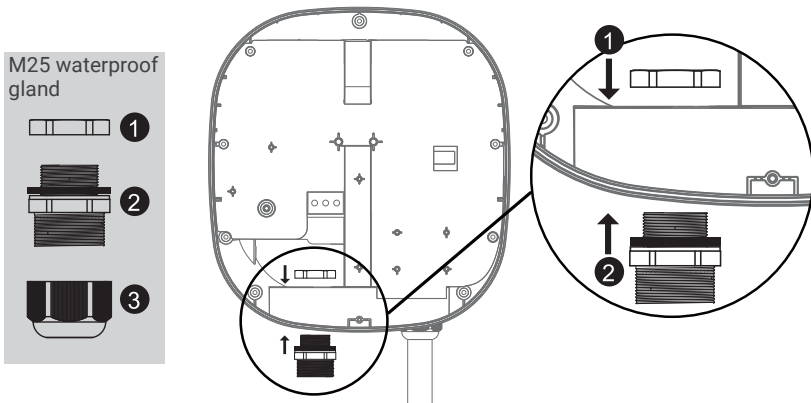

STEP 3

15~18mm of the insulation sheath should be stripped off the three AC wires. Take out the included needle terminal and install the needle terminal on the three GND/PE, L1/L, L2/N wires. Pass the three wires through the M25 waterproof gland Part 3.

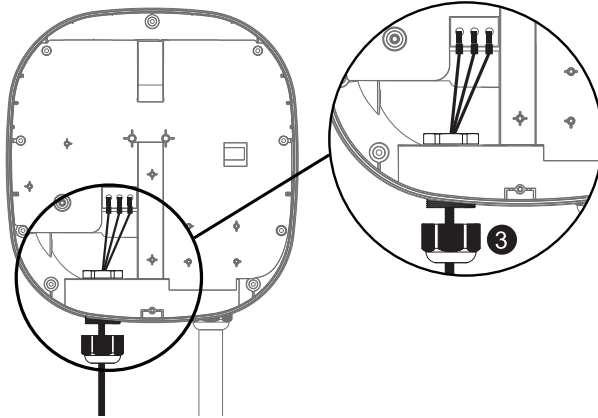

STEP 4

Insert the three wires into the wire holes of the green terminal block to the corresponding GND/PE, L1/L, L2/N and lock them. The recommended screw torque is 1.5 N.m (13.3 lbf.in).

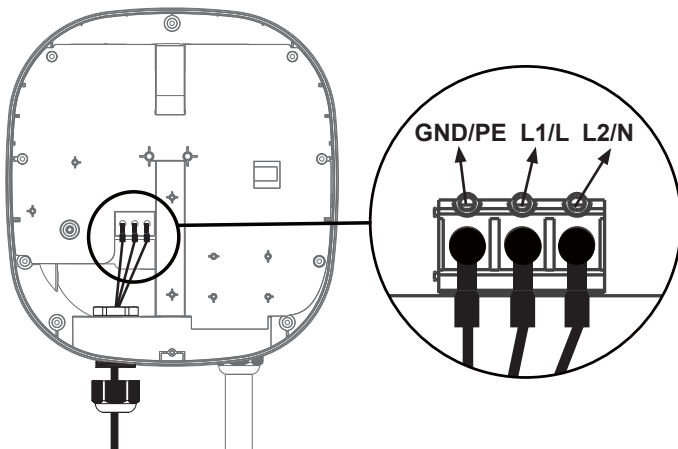

STEP 5

(For Internet Edition model with 4G function)

The SIM card slot is located on the right side. Insert the SIM card according to the image below.

Important Note: Before installing the SIM card to the charger, it is necessary to confirm that the SIM card has been activated and the password has been cancelled.

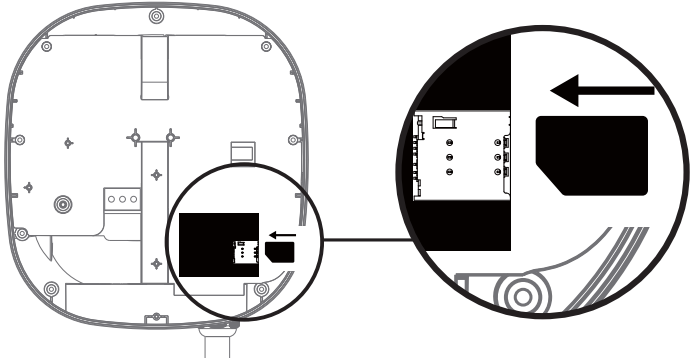

STEP 6

Upon completion, lock the M25 waterproof gland Part 3, and affix and tighten the 9 screws on the front cover. The recommended screw torque is 0.7 N.m (6.2 lbf.in)

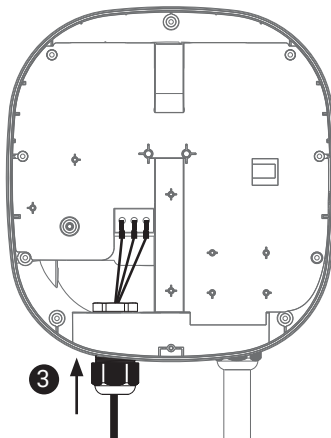

7.6 Wall-Mount Bracket Installation

STEP 1

Use the 4 sets of expansion and M6 screws to attach the wall-mount bracket on the wall

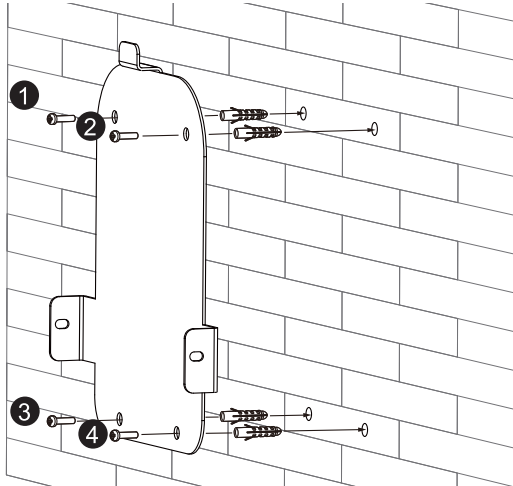

STEP 2

Align the rear notch of charger into the wall-mount bracket and align the screw holes of the right and left sides.

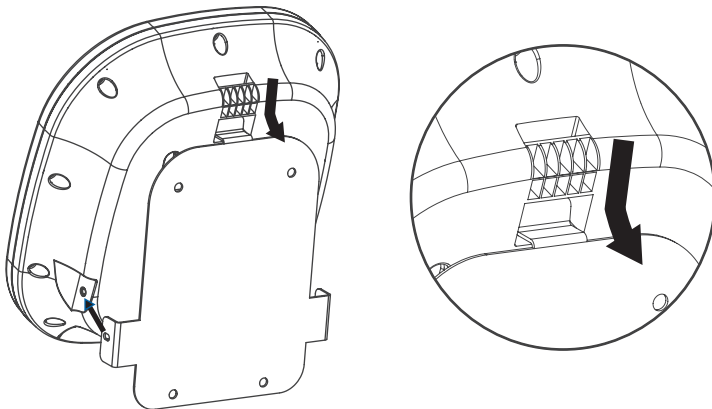

STEP 3

Attach with the M4 screws to complete the installation.

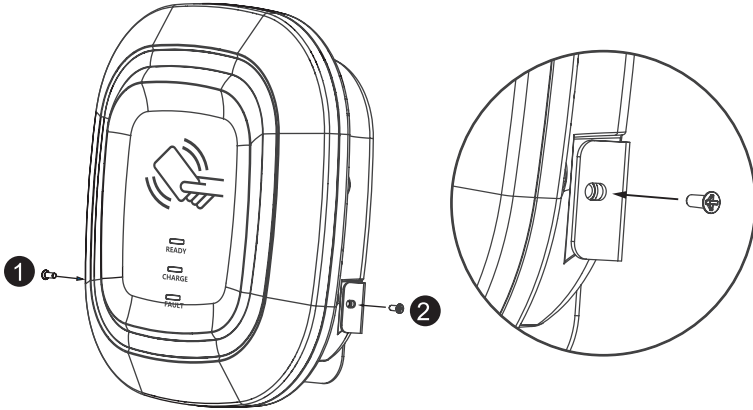

Overall outlook picture after installation:

- Wall-mount cable winding
- With Optional Cable Hook (optional accessory)

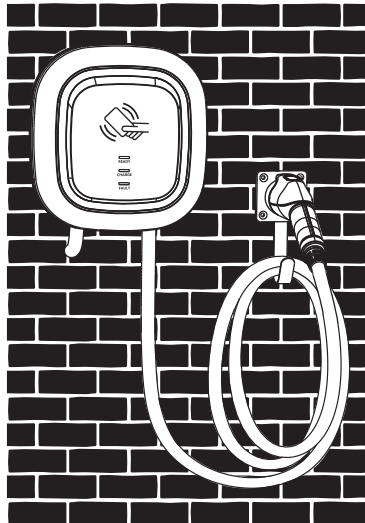
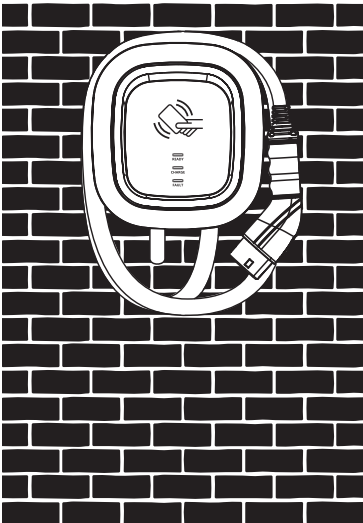

8. Operating Instructions

8.1 Operating Procedures

- User authorization (Only for Internet Edition)
- Connect to Vehicle Charging Inlet
- Charging Message
- Charging completed

8.2 Operating Steps – Non-Networking Edition

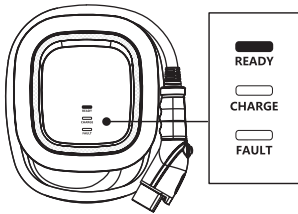

STEP1 / Standby Mode

After power-on, the green (READY), blue (CHARGE), and red lights (FAULT) will all temporarily light up. The charger will then enter standby mode, and the green light (READY) will remain lit. This could take up to 90 seconds.

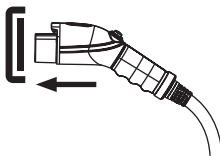

STEP2 / Connection to Vehicle Inlet

Plug the charging cable into the vehicle charging inlet. The blue light (CHARGE) is constantly lit.

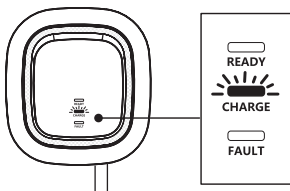

STEP3 / Charging

When the blue light (CHARGE) starts to flash automatically, the charging process has begun.

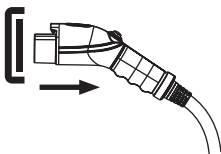

STEP4 / Charging Finished

When the charging session is complete, the blue light (CHARGE) will remain lit. Press the button to stop charging.

8.3 Operating Steps – Networking Edition

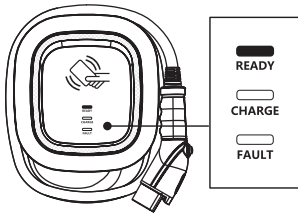

STEP1 / Standby Mode

After power-on, the green (READY), blue (CHARGE), and red lights (FAULT) will all light up. The charger will then enter standby mode, and the green light (READY) will remain lit. This could take up to 90 seconds.

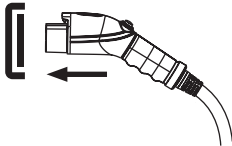

STEP2 / Tap the RFID Card

Plug the charging connector into the vehicle charging inlet. If you tapped the RFID card first, you will need to complete the insertion of the charging connector within 180 seconds. Otherwise, you will need to tap the RFID card again.

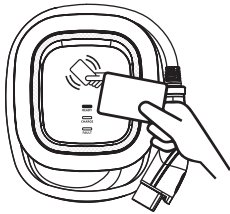

STEP3 / Tap the RFID Card

Tap the RFID card to start the charging session.

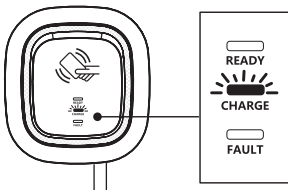

STEP4 / Charging

The blue light (CHARGE) automatically flashes during the charging session.

- If the red light (FAULT) is lit, proceed to plug the vehicle connector again.
- If the red light is still lit, please refer to "Error and Warning Messages".

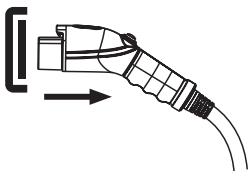

STEP5 / Charging Finished

When the charging session is complete, the blue light (CHARGE) will stay lit. Press the button on the connector to stop the charging session.

8.4 Time setting (Networking, Wi-Fi and 4G Editions)

Automatic setting :

The time will be adjusted automatically when the charger connects to internet.

Time Server :

- time.windows.com
- cn.ntp.org.cn
- tock.stdtime.gov.tw

Note: The Firewall and network environment may influence the time server connection.

Manual setting :

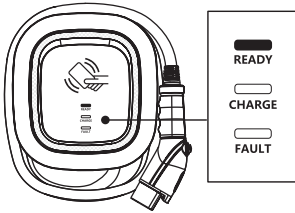

STEP1/ After power-on, the green (READY), blue (CHARGE), and red lights (FAULT) will all light up. The charger will then enter standby mode, and the green light (READY) will remain lit. This could take up to 90 seconds.

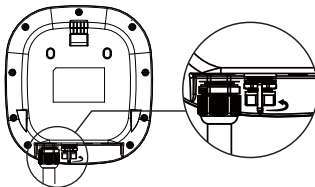

STEP2/ On the bottom of the unit, you will find the RJ45 connector port knob. Turn the knob counterclockwise as shown on the left to open and access the RJ45 female connector.

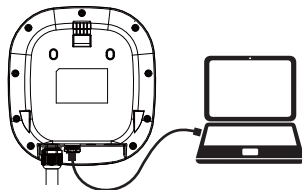

STEP3/ Connect the RJ45 cable to the charger. Connect the RJ45 cable to the notebook.

Use the following IP address:

IP address:

Subnet mask:

Default gateway:

STEP4/ Change the IP Address on your laptop computer by accessing the network card settings. Change the TCP / IP automatic IP to fixed IP.

- IP Address: 192.168.1.1
- Subnet Mask: 255.255.255.0

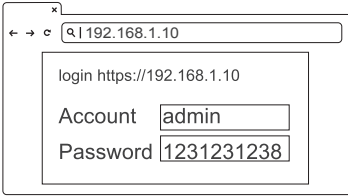

STEP5/ Open a browser and enter IP Address 192.168.1.10 to login into the setup page. Use the following credentials to login.

- Account: admin
- Password: 1231231238

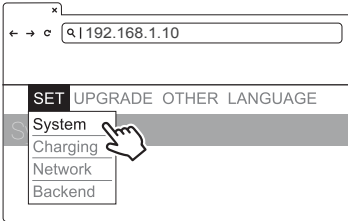

STEP6/ Select "SET" at the top of the webpage to enter the settings page. Select "Network" to enter the network settings page.

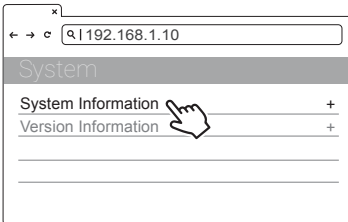

STEP7/

- Click "System information".

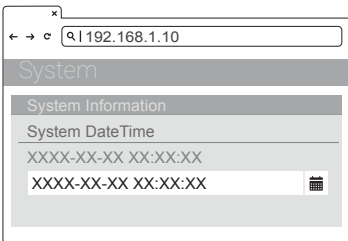

STEP8/

- Click System DateTime.
- Click the calendar graphic on the right to set the current time.

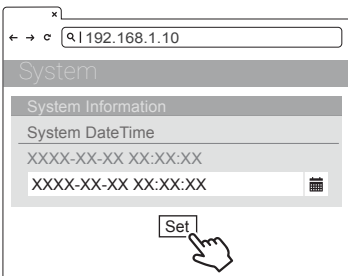

STEP9/ After you update the settings, click SET and wait until the setting completion window appears.

- For the Networking Edition, restart the charger.
- For Wi-Fi and 4G versions, continue to step 8.5 or 8.6 to complete the settings process.

8.5 Wi-Fi Setup (for the optional Wi-Fi Edition)

Tools required before setting

- Notebook with RJ45 interface x 1
- One RJ45 cable connector is male to male x1

Wi-Fi Setting

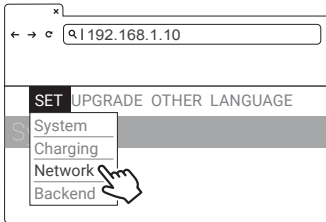

STEP1/ Select "SET" at the top of the webpage to enter the settings page. Select "Network" to enter the network settings page.

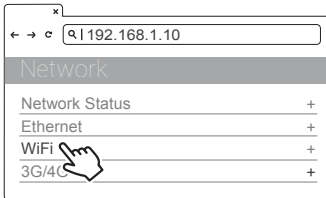

STEP2/ Select Wi-Fi to enter the Wi-Fi Module settings page.

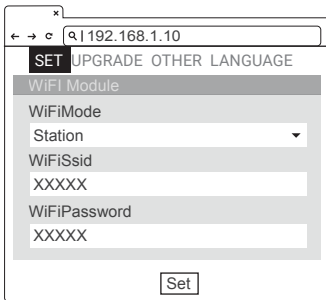

STEP3/ Keep the Wi-Fi Mode set to "Station" and enter the Wi-Fi SSID name and the Wi-Fi password. Save settings by selecting SET.

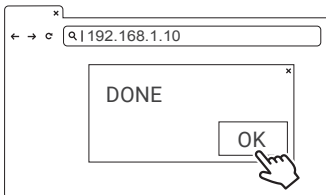

STEP4/ After completion, click SET and wait until the setting completion window appears. Restart the charger.

- For other settings (such as OCPP, etc.), please contact our professional staff.

8.6 4G Setup (for the optional 4G Edition)

Attention: Before installing the SIM card to the charger, it is necessary to confirm that the SIM card has been activated and the password has been cancelled.

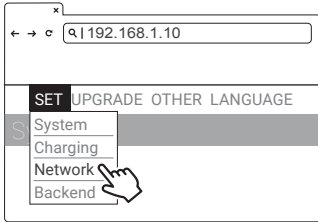

STEP1/ Select "SET" at the top of the webpage to enter the settings page. Select "Network" to enter the network settings page.

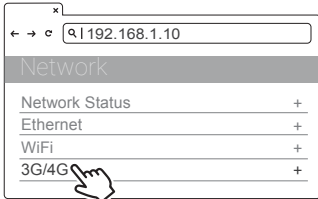

STEP2/ Select 3G/4G module to enter the 4G settings page.

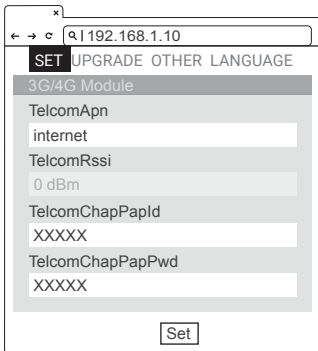

STEP3/ Enter the Carrier APN and then click "OK." Wait for the page to refresh. The page should now show RSSI, and the Network Connection "Status" should show "Connected."

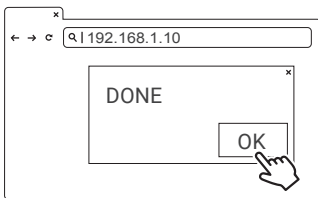

STEP4/ After completion, click SET. Wait for the setting completion window to appear. Click "Confirm" to finish the setting. Restart the charger.

*For other settings (such as OCPP, etc.), please contact our professional staff.

8.7 Re-checking the Wi-Fi and 4G Signal Strength on Power-Up.

After restarting the charger, check the connection signal strength. The RSSI (Received Signal Strength Indication) should be higher than -65dBm. If the value is lower, you may experience a weak Wi-Fi signal connection or even disconnection. The cause could be interference.

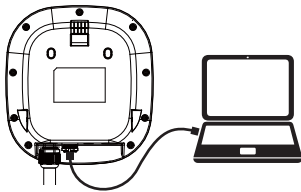

STEP1/ Connect the RJ45 cable to the charger. Connect the RJ45 cable to the notebook.

Use the following IP address :

IP address:

Subnet mask:

Default gateway:

STEP2/ Change the IP Address on your laptop computer by accessing the network card settings. Change the TCP / IP automatic IP to fixed IP.

- IP Address:192.168.1.1
- Subnet Mask::255.255.255.0

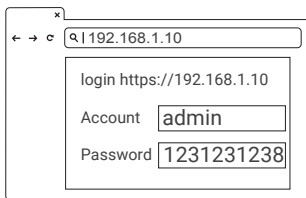

STEP3/ Open a browser and enter IP Address 192.168.1.10 to login into the setup page. Use the following credentials to login.

- Account: admin
- Password: 1231231238

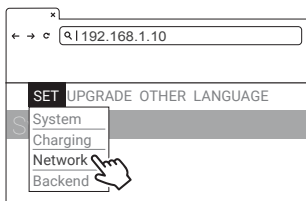

STEP4/ Select "SET" at the top of the webpage to enter the settings page. Select " Network" to enter the network settings page.

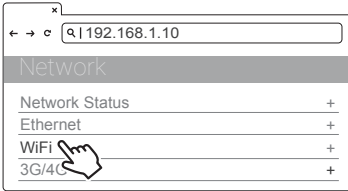

STEP5/ Select the Wi-Fi and 3G/4G module to enter the setting.

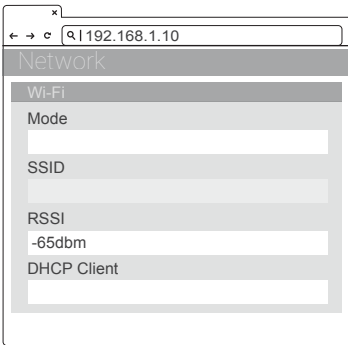

STEP6/ (Wi-Fi Version)

- Make sure the Wi-Fi strength is higher than -65dbm.

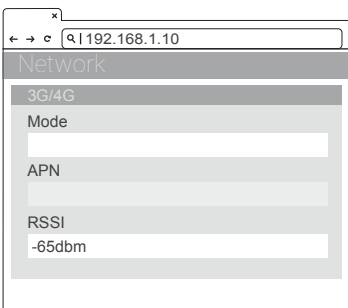

STEP6/ (4G Version)

- Check that the strength of 4G must be higher than -65dbm.

8.8 Error and Warning Message

Status	Blue	Green	Red	Remark
Input OVP	-	-	One flash followed by a 3-sec pause	Auto Recover
Input UVP	-	-	Two flashes followed by a 3-sec pause	Auto Recover
Output OCP	-	-	Three flashes followed by a 3-sec pause	Auto Recover
OTP	-	-	Four flashes followed by a 3-sec pause	Auto Recover
RCD Abnormal	-	-	Five flashes followed by a 3-sec pause	Auto Recover
Ground Fault* ¹	-	-	Six flashes followed by a 3-sec pause	Auto Recover
Control Pilot Fault	-	-	Flicker	Auto Recover
MCU Self-Test Fail	-	-	Constantly Bright	Contact Customer Service
RCD Self-Test Fail	-	-	Constantly Bright	Contact Customer Service
Relay Self-Test Fail	-	-	Constantly Bright	Contact Customer Service
RCD Abnormal Stop Charging* ²	-	Constantly Bright	Constantly Bright	Contact Customer Service* ³
Output OCP Stop Charging* ²	Constantly Bright	-	Constantly Bright	Contact Customer Service* ³
OTP Stop Charging	Flicker	Flicker	Constantly Bright	Contact Customer Service

*1 Verify that the Wall Connector is properly grounded. The Ground connection must be bonded in the upstream power supply for proper operation. Check all physical connections, including the wirebox terminals, electrical panel(s), and junction boxes. In residential power supplies, check the bond between Ground and neutral at the main panel. If connected to a step- down transformer, contact the transformer's manufacturer for direction on how to bond the ground connection.

*2 Withdraw and re-plug the charging gun can exit this stop charging mode.

*3 If this stop charging mode is frequently triggered, please contact customer service for technical solutions.

9. Federal Communication Commission Interference Statement

This device complies with Part 15 of the FCC Rules. Operation is subject to the following two conditions: (1) This device may not cause harmful interference, and (2) this device must accept any interference received, including interference that may cause undesired operation.

This equipment has been tested and found to comply with the limits for a Class B digital device, pursuant to Part 15 of the FCC Rules. These limits are designed to provide reasonable protection against harmful interference in a residential installation. This equipment generates, uses and can radiate radio frequency energy and, if not installed and used in accordance with the instructions, may cause harmful interference to radio communications. However, there is no guarantee that interference will not occur in a particular installation. If this equipment does cause harmful interference to radio or television reception, which can be determined by turning the equipment off and on, the user is encouraged to try to correct the interference by one of the following measures:

- Reorient or relocate the receiving antenna.
- Increase the separation between the equipment and receiver.
- Connect the equipment into an outlet on a circuit different from that to which the receiver is connected.
- Consult the dealer or an experienced radio/TV technician for help.

FCC Caution: Any changes or modifications not expressly approved by the party responsible for compliance could void the user's authority to operate this equipment.

This transmitter must not be co-located or operating in conjunction with any other antenna or transmitter.

Radiation Exposure Statement:

This equipment complies with FCC radiation exposure limits set forth for an uncontrolled environment. This equipment should be installed and operated with minimum distance 20cm between the radiator & your body.

10. Industry Canada statement

This device complies with ISED's licence-exempt RSSs. Operation is subject to the following two conditions: (1) This device may not cause harmful interference, and (2) this device must accept any interference received, including interference that may cause undesired operation.

Le présent appareil est conforme aux CNR d'ISED applicables aux appareils radio exempts de licence. L'exploitation est autorisée aux deux conditions suivantes : (1) le dispositif ne doit pas produire de brouillage préjudiciable, et (2) ce dispositif doit accepter tout brouillage reçu, y compris un brouillage susceptible de provoquer un fonctionnement indésirable.

Radiation Exposure Statement:

This equipment complies with ISED radiation exposure limits set forth for an uncontrolled environment. This equipment should be installed and operated with greater than 20cm between the radiator & your body.

Déclaration d'exposition aux radiations:

Cet équipement est conforme aux limites d'exposition aux rayonnements ISED établies pour un environnement non contrôlé. Cet équipement doit être installé et utilisé à plus de 20 cm entre le radiateur et votre corps.

This device is intended only for OEM integrators under the following conditions: (For module device use)

- 1) The antenna must be installed and operated with greater than 20cm between the antenna and users, and
- 2) The transmitter module may not be co-located with any other transmitter or antenna.

As long as 2 conditions above are met, further transmitter test will not be required. However, the OEM integrator is still responsible for testing their end-product for any additional compliance requirements required with this module installed.

Cet appareil est conçu uniquement pour les intégrateurs OEM dans les conditions suivantes: (Pour utilisation de dispositif module)

- 1) L'antenne doit être installé et exploité avec plus de 20 cm entre

l'antenne et les utilisateurs, et

2) Le module émetteur peut ne pas être coimplanté avec un autre émetteur ou antenne.

Tant que les 2 conditions ci-dessus sont remplies, des essais supplémentaires sur l'émetteur ne seront pas nécessaires. Toutefois, l'intégrateur OEM est toujours responsable des essais sur son produit final pour toutes exigences de conformité supplémentaires requis pour ce module installé.

IMPORTANT NOTE:

In the event that these conditions can not be met (for example certain laptop configurations or co-location with another transmitter), then the Canada authorization is no longer considered valid and the IC ID can not be used on the final product. In these circumstances, the OEM integrator will be responsible for re-evaluating the end product (including the transmitter) and obtaining a separate Canada authorization.

NOTE IMPORTANTE:

Dans le cas où ces conditions ne peuvent être satisfaites (par exemple pour certaines configurations d'ordinateur portable ou de certaines co-localisation avec un autre émetteur), l'autorisation du Canada n'est plus considéré comme valide et l'ID IC ne peut pas être utilisé sur le produit final. Dans ces circonstances, l'intégrateur OEM sera chargé de réévaluer le produit final (y compris l'émetteur) et l'obtention d'une autorisation distincte au Canada.

11. Maintenance and Repair

11.1 Daily Maintenance

Please keep the charger clean and keep the charger in a clean area with low humidity. Do not install it in an environment near the sea, with high oil, high humidity or high dust.

- Avoid moisture or water in the charger. If water or excess moisture gets into the charger, immediately power off the charger to avoid immediate danger. Proceed to contact the appropriate maintenance personnel before the next use.
- If there is any damage or dirt on the vehicle connector, charging cable, or vehicle connector holder, please contact the maintenance personnel immediately.
- Please use the charger correctly. Do not hit or press hard on the case. If the case is damaged, please contact a professional technician.
- Avoid placing the charger near hot objects and at high-temperature locations and away from dangerous substances such as flammable gases and corrosive materials.
- Do not place external objects or heavy objects on the charger to avoid danger.

11.2 Maintenance Spares

- This product is covered by a two-year parts warranty. If you have a technical issue, contact Dealer to speak to a technical support representative.

11.3 Warranty and Maintenance

- The warranty period for this charger is two years and covers parts only.
- All replacement parts provided during the warranty period will be covered for the remaining balance of the original warranty period, in addition to a 90-day grace period.
- During the warranty period, if any repair or maintenance is

performed, an additional 90-days will be added to the original warranty period

- During the warranty period, if any malfunction is caused by regular use in accordance with the user manual and service instructions (to be determined by Delar), the shall be repaired free of charge. Except for the following situations, the charger shall be subject to the above warranty terms:
 1. The inability to provide valid proof of purchase
 2. A product that is out of warranty.
 3. Those who damage the product due to not following the product service instruction for use, maintenance and storage.
 4. Damage or malfunction caused by a foreign object entering.
 5. Unauthorized repair, disassembly or modification.
 6. Damage caused by force majeure (such as lightning, excessive voltage, earthquake, fire, flood, etc.).
 7. Malfunction and damage caused by other unavoidable external factors. Malfunction and damage caused by improper use of equipment, such as water or other solutions entering into the equipment.
 8. Malfunction and damage caused by the grid power supply and voltage which is not specified for use with the charger equipment.

11.4 Maintenance History

Product Name _____ Serial No. _____

Product Model _____

Manufacture Date _____ Year _____ Month _____ Day _____

Customer _____

Phone _____

Address _____

1.Maintenance Content

After Service _____ Signature of Customer _____

2.Maintenance Content

After Service _____ Signature of Customer _____

3.Maintenance Content

After Service _____ Signature of Customer _____

4.Maintenance Content

After Service _____ Signature of Customer _____

5.Maintenance Content

After Service _____ Signature of Customer _____



┌

└